

# Flame-Proof Signal Tower Lamp

## QST50-Ex Series

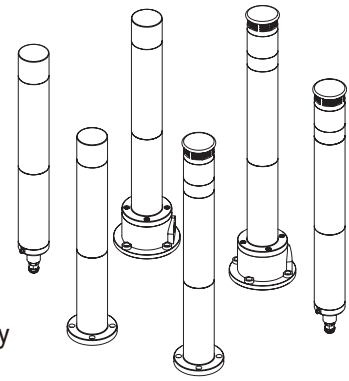

Thank you for purchasing Qlight's products. Please read this user manual carefully prior to installation and operation to ensure safe and correct use.

### **! Safety Precautions for Explosion Proof Products**

**Please follow the instruction below to ensure safe and correct use of explosion proof products.**

1. Explosion proof products should be managed according to explosion proof regulations. Do not disassemble, assemble, alter or repair the product arbitrarily.
2. The temperature rating of the product is the temperature the product will experience at the applied rated voltage and ambient temperature indicated.
3. Use cable glands that satisfy the product's explosion proof grade and temperature grade.
4. Unused cable entries must be filled with material that meets the explosion proof grade and temperature rating.
5. Before installing the product, please make sure all cautions indicated on the labels, packaging, and operation manual of the product are fully understood.
6. Installation, maintenance and repair of the product must be performed by experts in the explosion proof field, or persons who have received relevant training.
7. For safety, the product should be installed and operated in environments that avoid high temperature and high pressure.
8. Please follow general safety precautions and avoid installing the product in locations that may generate excessive heat.
9. When installing the product in places where chemicals are located, please make sure that the environment does not have two or more incompatible chemicals mixed. For safety, please read the instruction manual carefully and be mindful of the chemical compositions where the product is used.
10. This product requires grounding.
11. The manufacturer has maintained larger length, more stringent gap and a greater number of thread engagement of flameproof joints required by the standard. Hence, the user must refer to manufacturer before carrying out any repair or refurbishment to the equipment.  
The flame path length and gap specified in the certification drawings must never be modified.
12. The fastening screws for enclosure base body and terminal body shall be socket head cap screws made of stainless steel of size M5x0.8, 15L, property class A2-70 with minimum yield strength of 450 MPa.
13. Potential electrostatic charging hazard - See instructions. Care should be taken during installation and cleaning to avoid risk of ignition due to electro-static discharge. Cleaning of non-metallic surface must be done with a damp cloth only.
14. The equipment input should be made through the "Ex d", IEC 60079-1 certified cable gland.
15. The manufacturer has maintained a greater number of threads for engagement than required by the standard at cable entries. User must ensure full thread engagement all the times.

### **! Precautions for Safety**

**Failure to follow the instructions below may cause a loss of life or serious physical injury.**

1. During wiring or maintenance, please completely turn off the power of the product. (Failure to follow this may lead to an electric shock.)
2. Do not install the product in locations that subjects it to excessive dust or water other than the conditions designated by the IP protection ratings indicated for each product. (Failure to follow these instructions may cause a fire to the product, electric shock, physical injury, malfunction or damage to the product.)
3. Do not alter or repair this product. If maintenance or repair service is required, please contact your local Qlight contact point. (Failure to follow these instructions may lead to fire, electric shock, or product damage.)
4. Please apply the correct voltage to the product. (Failure to follow these instructions may lead to fire, electric shock, or product damage.)
5. When the product is applied to a condition that may impact lives or property, please make sure to have a double safety device. (Failure to follow this may cause damage to property, fire, electric shock and loss of life.)

### **! Precautions for Correct Use**

**Failure to follow the proper instructions may cause damage to property, the product, or malfunction of the product that would void the warranty.**

1. Please remove any objects that can interrupt ventilation around the product.
2. Please turn off the power of the product immediately if it fails to operate properly.
3. Carefully wire the product according to each product's specification.
4. Please be careful in preventing chemicals such as thinner, benzene, etc. in contact with the surface of the product.
5. Do not apply excessive force/impact to the product.
6. Failure to follow any of the instructions above may cause malfunction or damage to the product, fire, and electric shock.



Please scan the QR code for more detailed product information.



[www.qlight.com](http://www.qlight.com)

## Ordering Specifications

<b>QST50-Ex</b>	-	<b>5</b>	-	<b>24</b>	-	<b>RAG</b>
[Model number]		[Layer count]		[Voltage]		[Color]
<ul style="list-style-type: none"> <li>• QST50-Ex</li> <li>• QST50B-Ex</li> <li>• QST50T-Ex</li> <li>• QST50BT-Ex</li> <li>• QST50M-Ex</li> <li>• QST50BM-EX</li> </ul>		<ul style="list-style-type: none"> <li>• 5-5 Layers</li> </ul>		<ul style="list-style-type: none"> <li>• 24-DC24V</li> <li>• 110/230-AC110V-230V</li> </ul>		<ul style="list-style-type: none"> <li>R-Red</li> <li>A-Amber</li> <li>G-Green</li> <li>B-Blue</li> <li>W-White</li> </ul>





## Product Specifications





### Explosion Proof Specifications

Model number	QST50 / 50T / 50M-Ex QST50B / 50BT / 50BM-Ex
Range for operating voltage	DC24V AC110V-230V
Ex mark	IECEX - Ex db IIC T6 Gb Ex tb IIIC T85°C Db ATEX -  II 2G Ex db IIC T6 Gb  II 2D Ex tb IIIC T85°C Db KCs - Ex db IIC T6 Gb, IP66/IP67
Ambient operating temperature	-40°C ≤ Tamb ≤ +60°C
Explosion proof Zone	Zone 1, Zone 2
Protection rating	IP66

Zone definitions(Gas)	Zone 1	High risk gas/vapour		
	Zone 2	Medium risk gas/vapour		
Group definitions(Gas)	GROUP II A	Acetone, Petrol, Methanol, Propane, Toluene		
	GROUP II B	Ethylene, City gas		
	GROUP II C	Hydrogen, Acetylene, Carbon sulphide		
Maximum surface temperature of electrical equipment	T1	450°C	T4	135°C
	T2	300°C	T5	100°C
	T3	200°C	T6	85°C
Zone definitions(Dust)	Zone 21	High risk powder/dust		
	Zone 22	Medium risk powder/dust		
Group definitions(Dust)	GROUP II A	Ignitable fibers/flyings(more than 0.5mm)		
	GROUP II B	Non-conductive dusts		
	GROUP II C	Conductive dusts		

### General Product Specifications

Model number	Layer	Voltage	Certificate	Weight	Color
QST50 QST50T QST50M (Steady/ Flashing)	5	DC24V	   	1.29Kg 2.00Kg 1.21Kg	R-Red A-Amber G-Green B-Blue W-White
		AC110V-230V			

Model number	Layer	Voltage	Certificate	Weight	Color
QST50B QST50BT QST50BM (Steady/ Flashing)	5	DC24V	   	1.47Kg 2.21Kg 1.39Kg	R-Red A-Amber G-Green B-Blue W-White
		AC110V-230V			

### Light source current(based on 1 layer)

Voltage	DC24V	AC110V-230V
Light source current(1 layer)	75mA	Max.55mA

### Light source/buzzer current(based on 1 layer)

Voltage	DC24V	AC110V-230V
Light source current(1 layer)	75mA	Max.55mA
Buzzer current	50mA	Max.40mA

QST50-Ex

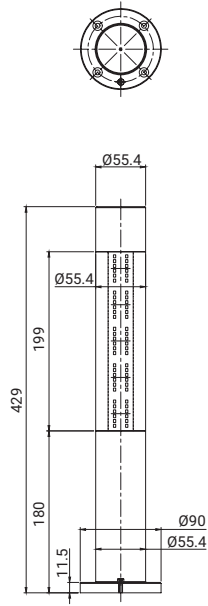

HOLE FOR CABLE ENTRY  
Quantity : 1  
Size : M12xP1.5 or M16xP1.5

QST50B-Ex

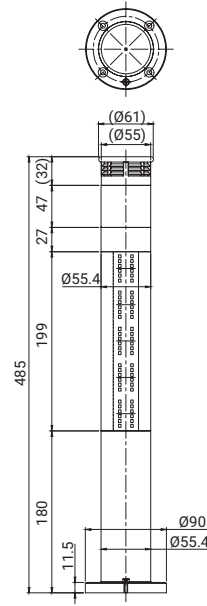

HOLE FOR CABLE ENTRY  
Quantity : 1  
Size : M12xP1.5 or M16xP1.5

QST50T-Ex

HOLE FOR CABLE ENTRY  
Quantity : 2  
Size : M16, M20xP1.5 or NPT 1/2, 3/4

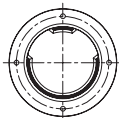
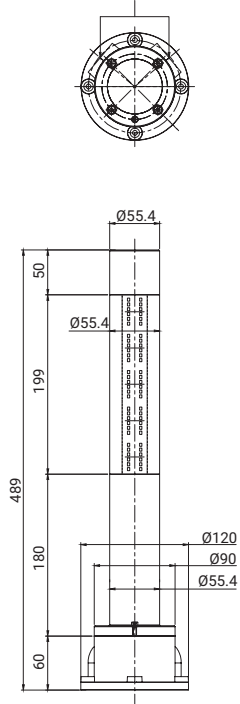

QST50BT-Ex

HOLE FOR CABLE ENTRY  
Quantity : 2  
Size : M16, M20xP1.5 or NPT 1/2, 3/4

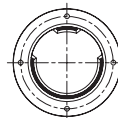
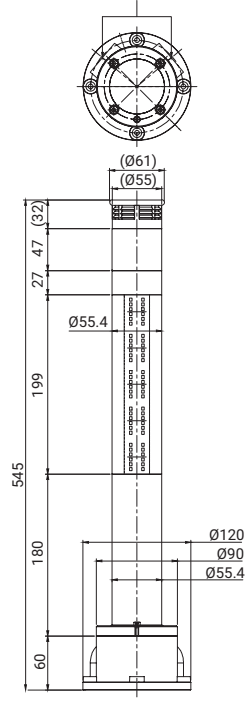

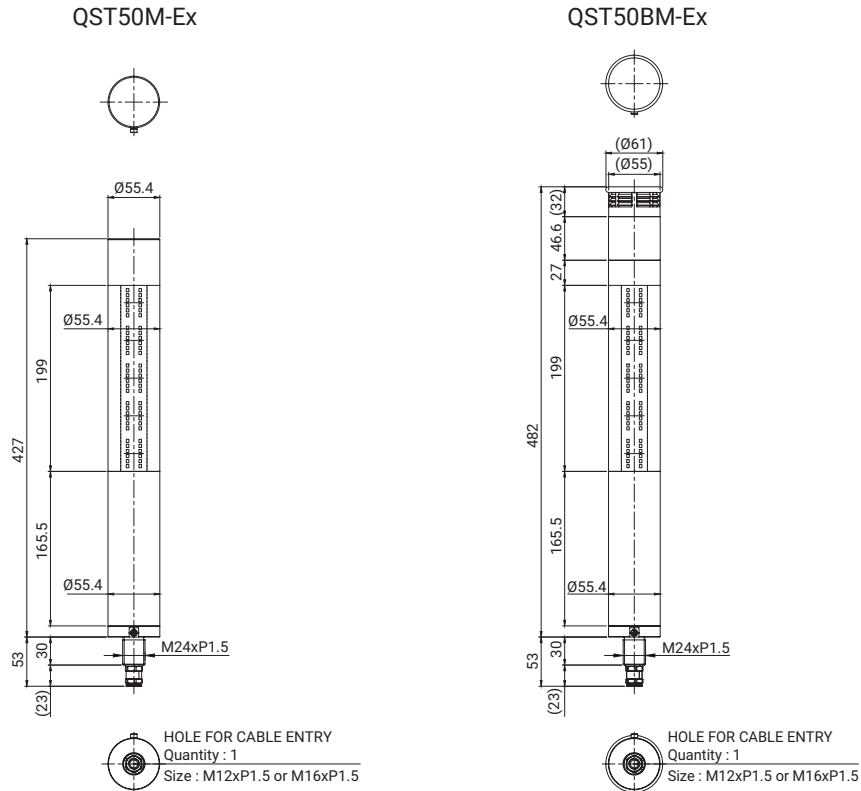

Grounding Instructions

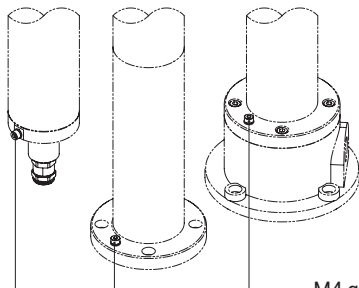

M4 ground contact part

- Please use an M4 bolt at the location marked in the diagram above to ground the product.
- When connecting the grounding cable, please use a ring terminal.
- Please use a grounding cable with a diameter greater than 4mm.
- Please make sure to ground the common line(-) of the product.

Explosion proof product label

• All equipment that are used in explosive environment must have a label showing on following details in accordance with International Electrotechnical Commission(IEC) Regulation 60079-0.

ATEX, IECEx explosion proof certification



**FLAME-PROOF SIGNAL TOWER LAMP**

TYPE: QST50-Ex

PROTECTION: • Ex db IIC T6 Gb

GRADE: • II 2G Ex db IIC T6 Gb  
• Ex tb IIIIC T85° Db  
• II 2D Ex tb IIIIC T85° Db  
• IP 66

CERT NO. • IECEx ICR 26.0003X

TEMP. • ICR Polska 26 ATEX 0027 X

RATING: -40°C ≤ Tamb ≤ +60°C

CABLE ENTRY: M12xP1.5 or M16 x P1.5

SERIAL NO. \_\_\_\_\_

YEAR. \_\_\_\_\_

ADDRESS: 185-25, MUKBANG-RO  
GIMHAE-SI, KOREA

Qlight Co.,Ltd. <https://www.qlight.com>

LED Specification

• The maximum forward voltage and current ratings of the LEDs used in this product are as follows.

No.	Type	VF Max.	Current
1	R-LED	2.6V	20mA
2	A-LED	3.8V	60mA
3	G-LED	3.6V	30mA
4	B-LED	3.6V	60mA
5	W-LED	3.8V	60mA

## Wiring Instructions

- QST50(M)/ QST50B(M) model can be wired with either external contact and transistor.
- When wiring with transistor, please make sure to use PNP transistor and follow the wiring instructions in the diagram below.

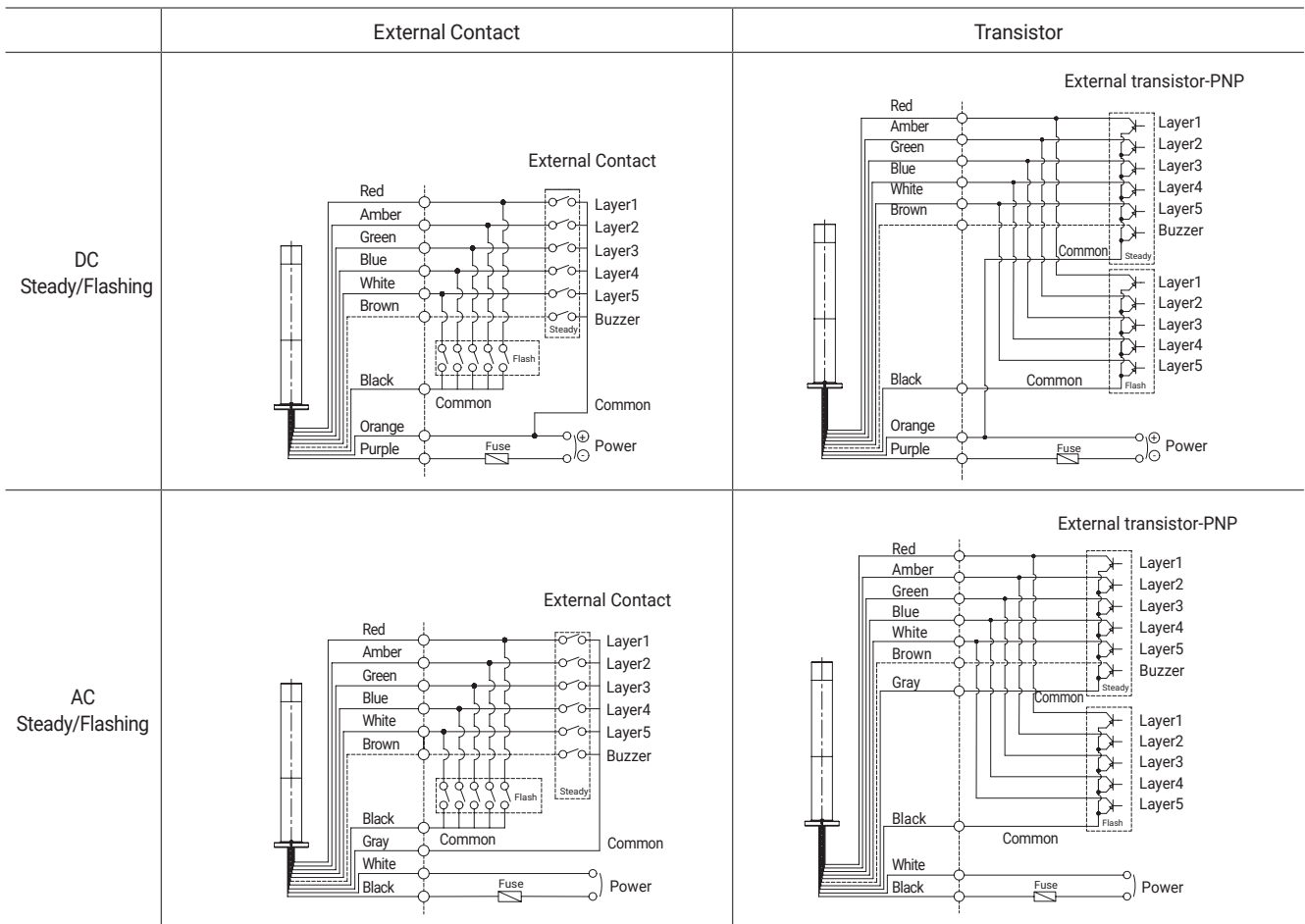

## Wiring Instructions

### ■ Terminal Block (QST50T/QST50BT)

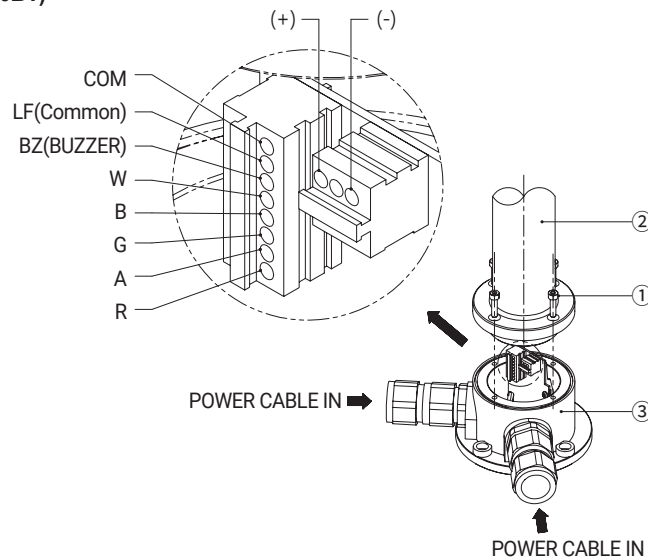

- Disassemble the Bolts(4x) from Tighten at Base body and Terminal body.
- Left up the Base body above drawing.
- The Power Cable Through the Cable gland connecting to each Terminal block.
- All unused cable gland holes shall be sealed. (Only Ex-certified stopping plug shall be used)
- ※ Please make sure to close the terminal block cover completely to prevent failure in waterproofing
- ※ Models QST50(B) and QST50M(B) are supplied with pre-wired power cables.

## Parts Definition/ Installation

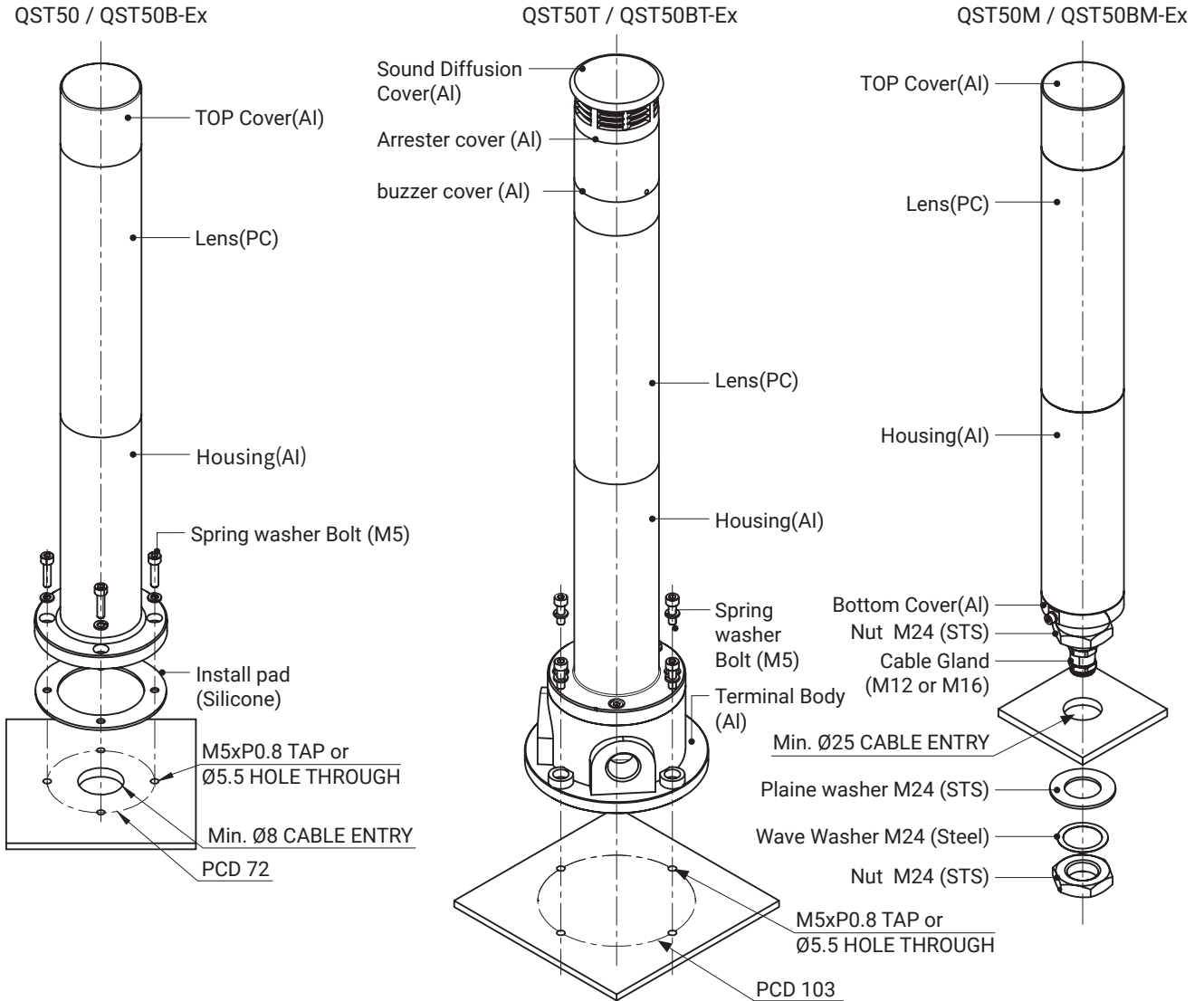

- First, machine taps or holes on the mounting surface.
- The mounting hole machining dimensions for each product specification are as follows.

MODEL	Mounting Hole or Tapped Hole	CABLE ENTRY
QST50-Ex	Ø6 or M5xP0.8 (4x)	Min. Ø8
QST50B-Ex	Ø6 or M5xP0.8 (4x)	Min. Ø8
QST50T-Ex	Ø6 or M5xP0.8 (4x)	N/A
QST50BT-Ex	Ø6 or M5xP0.8 (4x)	N/A
QST50M-Ex	N/A	Min. Ø25
QST50BM-Ex	N/A	Min. Ø25

- When machining taps, fasten the bolt through the mounting hole of the product.
- When machining holes, insert the bolt through the product and into the machined hole, then tighten the nut from the opposite side of the mounting surface.
- Depending on the installation environment, fix the bracket to the product cover or body for direct mounting or wall mounting.

## Installation Environment and Protection Rating

- This product is designed with an explosion-proof structure.
- Please make sure to use the product in an environment that satisfies the regulated explosion-proof grading.
- A cable gland is not included with this product. If the product is to be used in an outdoor environment requiring waterproof capability, please install the cable gland after applying separate sealing.
- For further information on the protection rating, please visit our website ([www.qlight.com](http://www.qlight.com)).

## Product installation direction

- Install the product in accordance with the manual. Otherwise rainwater or moisture may penetrate into the product.

### · BEACON/SIGNALING LIGHT

※ For products with a protection rating of less than IPX4, please install it vertically.

Power cord inlet part shall not be facing the sky.

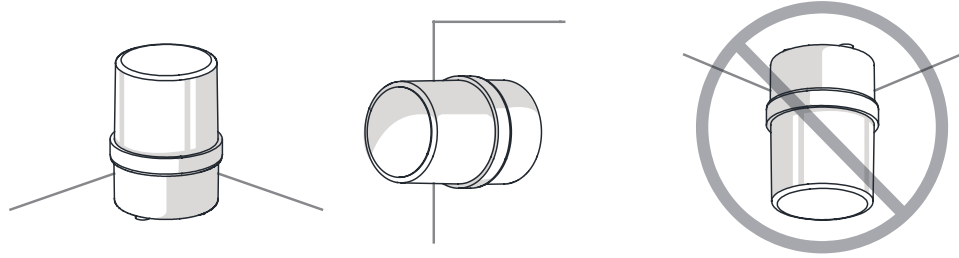

### · ELECTRONIC SOUNDER/SIGNAL HORN

Sounder part shall not be facing the sky.

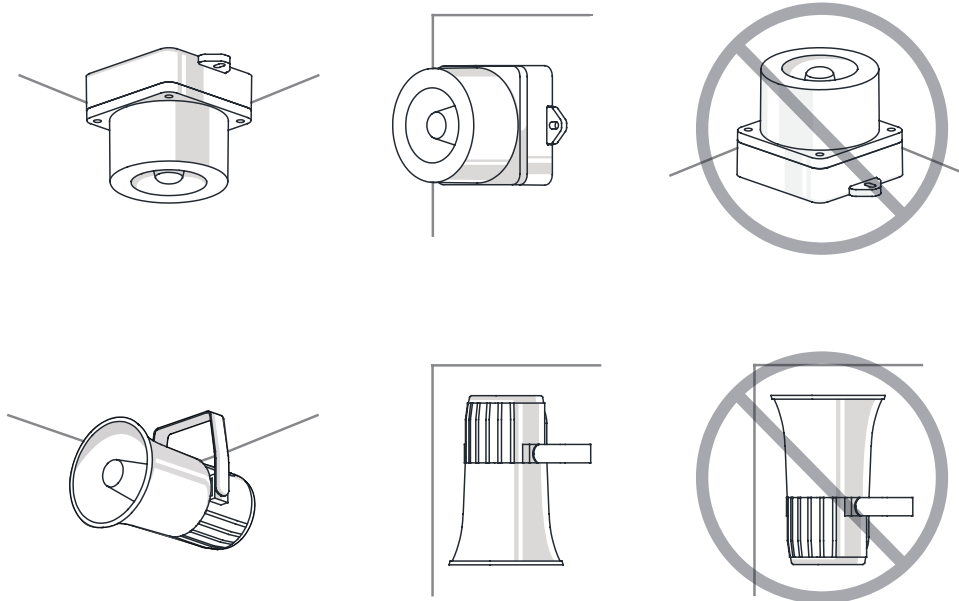

### · HEAVY-DUTY & EXPLOSION PROOF SIGNALINGS

Sounder part shall not be facing the sky.

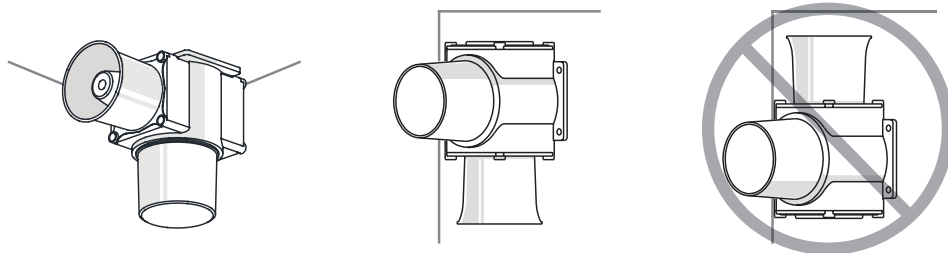

### · SIGNAL TOWER LIGHTS

※ For products with a protection rating of less than IPX4, please install it vertically.

Power cord inlet part shall not be facing the sky.

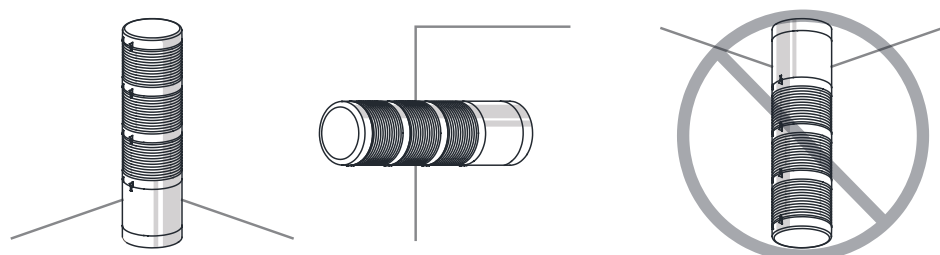



For your safety

Specification and dimensions listed in this catalogue subject to change without notice for product quality improvement.  
The newest product information is available on our website.(www.qlight.com)  
Please read the instruction manual attached to the product carefully before installation and use.

*Korea Corporation Qlight Co., Ltd. www.qlight.com | trade@qlight.com*

Head Office | Suite #1510, STX-V Tower, 128 Gasan Digital 1-ro, Geumcheon-gu, Seoul, 08507, South Korea

Tel: +82-2-2679-6152 Fax: +82-2-2679-6154

Factory(Gimhae Production Headquarters) | 185-25, Mukbang-ro, Sangdong-myeon, Gimhae-si, Gyeongsangnam-do, 50805, South Korea

Tel: +82-55-328-1111

Overseas Sales Department | Qlight Building, 704 Nakdong-daero, Sasang-gu, Busan 47044, South Korea Tel: +82-51-620-4100

Busan Business Center | Qlight Building, 704 Nakdong-daero, Sasang-gu, Busan 47044, South Korea Tel: +82-51-245-0017

---

*China Corporation SHANGHAI Qlight Electronic Co., Ltd. www.qlight.com www.qlightcn.com | qlightcn@qlight.com*

Sales Corporation (Shanghai) | Room 333 Building B, No.11, Lane 450, Zhenda Road, Baoshan District, Shanghai, China

Tel: +86-21-6651-7100 Fax: +86-21-6315-3929

Manufacturing Corporation (Qidong) | No.33, Haiyan Road, Qidong High-tech Industrial Development Zone, Qidong, Jiangsu Province, China

Tel: +86-513-8384-9999 Fax: +86-513-8384-9910

**Qlightec**

Innovation in Alarm & Signal

Product Operation Inquiry / Customer Support +82-51-620-4100

You can expect prompt service if you have exact information such as model name, symptom, telephone number and address.

※ ALL PRODUCT, PRODUCT SPECIFICATIONS AND DATA ARE SUBJECT TO CHANGE WITHOUT NOTICE TO IMPROVE RELIABILITY, FUNCTION OR DESIGN OR OTHERWISE.

Head office : Suite #1510, STX-V Tower, 128 Gasan digital 1-ro, Geumcheon-gu, Seoul, Korea (Postal Code : 08507)

Factory : 185-25, Mukbang-Ro, Sangdong-Myeon, Gimhae-Si, Gyeongsangnam-Do, Korea (Postal Code : 50805)

www.qlight.com

EN - KO - QST50-Ex - 2605A