

QT Series

New Model Concept which Allows for Significant Customization to Your Specific Needs Using Special Modular Components



- QT Series tower light is a multifunctional product that allows for significant customization to your specific needs using our special modular components such as the lens, buzzer, USB cord and Mounting brackets. Additional tools are not required for assembly
- All modular components can be arranged freely to the user desired position (upper/ lower) except for the dial tone lever



· Buzzer modules position can be chosen freely

The buzzer module is designed to be compatible with the light modules by using a novel architecture developed by Qlight. Therefore, users can reposition the module to the location they desire. In the photo to the left, the buzzer module is located at the top, center and bottom positions.



· Can select from a variety of LED light functions

The LED indicator can provide varying signals/actions by using different independent light modules; flashing, strobe, rotating. For example, green would indicate normal operation, a red module would indicate risk which can be highlighted further by selecting a strobe flashing or rotating module.

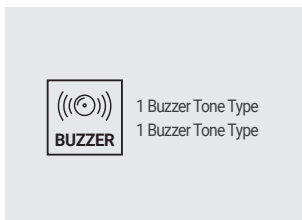

· Buzzer sound selection

Modules that output buzzer sounds can be arranged according to the work environment and purpose. For detailed specifications of the buzzer sound module, please refer to QT Series [Buzzer Module].



· Can select from a variety of pole selections to fit your application needs

You can choose from 8 different kinds of pole options for mounting. The pole materials vary from steel, aluminum, and polycarbonate. Please refer to [Tower Light Mounting Bracket] on this catalogue for detailed dimensions



· Module sales

Consumers can purchase the modules they need and assemble them themselves. Detailed specifications and features of the module are introduced on the QT50 / QT70 module information page. References for module combinations are included on the Assembly Instructions page.

· Assembly sales

We assemble the functions requested by consumers and supply them as finished products. Assembly specifications for various model numbers are introduced on the QT50 / QT70 product detail page.



QT50L / QT50ML
QT70L / QT70ML

Modular Multi-Functional LED Tower Lights

QT Series

Multi-functional module can be assemble to user requirements

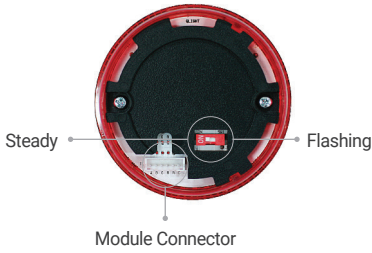

Please use the switch for Steady and Flashing which is on top of Q50L-F and Q70L-F, LED steady/flashing module.

Module Connection



1 Connect wire between module



2 Match the edge of module



3 To assemble turn right

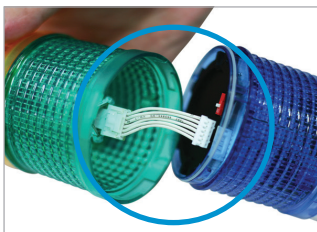

Uses a connector for easy assembly

LED module

- 4 kinds of LED modules; Steady, steady/flashing, strobe, revolving flashing
- Good visibility with high brightness.
- Module position can be chosen based on signal importance.



Q70L-N



Q50L-N

LED Steady Module

- Output LED Steady signal
- High brightness LED
- Voltage: DC12V, DC24V, AC110V, AC220V



Q70L-F



Q50L-F

LED Steady/Flashing Module

- Output LED Steady/Flashing signal
- High brightness LED
- Voltage: DC12V, DC24V, AC110V, AC220V



Q70L-S



Q50L-S

LED Strobe Module

- LED Strobe Module
- Excellent notice compare to flashing type
- Voltage: DC12V, DC24V



Q70L-R



Q50L-R

LED Revolving Flashing Module

- LED light revolve and flash
- Dynamic Signal
- Voltage: DC12V, DC24V

Buzzer module

- Buzzer module has Siren and Bip sound, Bip sound is adjustable.
- Buzzer module position can be chosen freely and has a good air tight seal.



Q70L-BZS

Siren Sound Buzzer Module

- Siren buzzer volume: Max.90dB
- Sound fixed
- Voltage: DC12V, DC24V, AC110V, AC220V



Q70L-BZ



Q50L-BZ

Bip Sound Buzzer Module

- Bip sound(Pi-Pi) volume : Max 90dB
- Sound adjustable
- Voltage: DC12V, DC24V, AC110V, AC220V



- Sound adjustable by lever on module side
- Buzzer module position can be chosen freely

Module Connection

- Adopts a convenient connector for easy assemble.
- Simple connection structure makes assembly straightforward and effortless when compared to other manufacturer's products.

Base Module is composed of the control line and threaded to the Mounting bracket for improved product mounting efficiency.
Please refer to below instruction and choose the mount type.

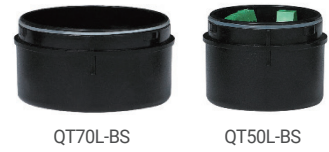

QT70L-BS

QT50L-BS

Base Module

- 6P terminal plate equipped on basic module. Please refer to QT Series wiring diagram for wiring of power line and signal line

Direct mount			3 Bolts on base module
Wall mount			Wall mount bracket on base module
Pole mount			Pole module and pole assemble on base module

Module Color

- Housing color of the QT series modular tower lights is black
- Customizable in beige color

Wiring Instructions

- QT series can be wired to External Contact and transistor
- In case of wiring with transistor, please select the proper transistor type either NPN or PNP based on the source voltage setting
- DC Steady type : External power/External signal line - UL1007 AWG22(0.3sq) 400mm
- AC Steady, AC/DC steady/flashing type :
External power line - UL1015 AWG18(0.75sq)×2C 400mm
External signal line - UL1007 AWG22(0.3sq)400mm

Mounting bracket

- Pole Mount Brackets

Standard	LB18 LB24	LW18 LW24	QZ18 QZ24	SZ18 SZ24	QL18 QL24	SL18 SL24
Steel	Steel	ABS	ABS	Al	ABS	Al

※ Please refer to [Tower Light Mounting bracket] on this catalogue for detailed dimensions

Power Line Wiring Instructions

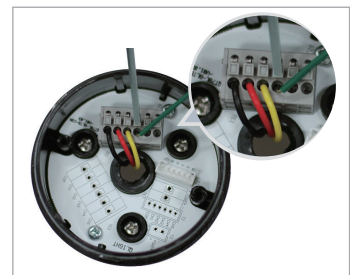

Terminal box can be wired without a special tool by using the push and release locking mechanism.

Modular Multi-Functional LED Tower Lights

QT50 Series



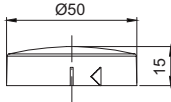

Module Specifications QT50L / QT50ML

(Units : mm)

Layout	Parts Name	Model No	Common Specifications
	QT50L Cover	Q50L-CV	<ul style="list-style-type: none"> · Material: PC · Protection ratings with assemble: IP65 · Product size: Ø50 x 15 

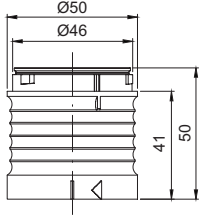

· LED Steady Module

(Units : mm)

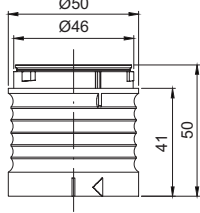

Layout	Parts Name	Model No	Specification		Common Specifications
			Voltage	Current	
	Q50L-NR Red LED Steady Module	Q50L-NR-12 Q50L-NR-24 Q50L-NR-110 Q50L-NR-220	DC12V DC24V AC110V AC220V	100mA 55mA 25mA 25mA	<ul style="list-style-type: none"> · Material: PC · Protection ratings with assemble : IP65 · Product size: Ø50 x 50 
	Q50L-NA Amber LED Steady Module	Q50L-NA-12 Q50L-NA-24 Q50L-NA-110 Q50L-NA-220	DC12V DC24V AC110V AC220V	100mA 55mA 25mA 25mA	
	Q50L-NG Green LED Steady Module	Q50L-NG-12 Q50L-NG-24 Q50L-NG-110 Q50L-NG-220	DC12V DC24V AC110V AC220V	100mA 55mA 25mA 25mA	
	Q50L-NB Blue LED Steady Module	Q50L-NB-12 Q50L-NB-24 Q50L-NB-110 Q50L-NB-220	DC12V DC24V AC110V AC220V	100mA 55mA 25mA 25mA	
	Q50L-NC White LED Steady Module	Q50L-NC-12 Q50L-NC-24 Q50L-NC-110 Q50L-NC-220	DC12V DC24V AC110V AC220V	100mA 55mA 25mA 25mA	

· LED Steady/Flashing Module

(Units : mm)



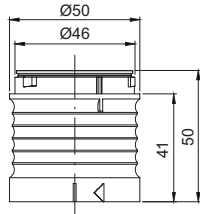

Layout	Parts Name	Model No	Specification		Common Specifications
			Voltage	Current	
	Q50L-FR Red LED Steady/Flashing Module	Q50L-FR-12 Q50L-FR-24 Q50L-FR-110 Q50L-FR-220	DC12V DC24V AC110V AC220V	100mA 55mA 25mA 25mA	<ul style="list-style-type: none"> · Material: PC · Protection ratings with assemble : IP65 · Product size: Ø50 x 50 
	Q50L-FA Amber LED Steady/Flashing Module	Q50L-FA-12 Q50L-FA-24 Q50L-FA-110 Q50L-FA-220	DC12V DC24V AC110V AC220V	100mA 55mA 25mA 25mA	
	Q50L-FG Green LED Steady/Flashing Module	Q50L-FG-12 Q50L-FG-24 Q50L-FG-110 Q50L-FG-220	DC12V DC24V AC110V AC220V	100mA 55mA 25mA 25mA	

(Units : mm)

Layout	Parts Name	Model No	Specification		Common Specifications
			Voltage	Current	
	Q50L-FB Blue LED Steady/Flashing Module	Q50L-FB-12	DC12V	100mA	<ul style="list-style-type: none"> · Material: PC · Protection ratings with assemble : IP65 · Product size: $\varnothing 50 \times 50$
		Q50L-FB-24	DC24V	55mA	
		Q50L-FB-110	AC110V	25mA	
		Q50L-FB-220	AC220V	25mA	
	Q50L-FC White LED Steady/Flashing Module	Q50L-FC-12	DC12V	100mA	
		Q50L-FC-24	DC24V	55mA	
		Q50L-FC-110	AC110V	25mA	
		Q50L-FC-220	AC220V	25mA	



· LED Strobe Module

(Units : mm)

Layout	Parts Name	Model No	Specification		Common Specifications
			Voltage	Current	
	Q50L-SR Red LED Strobe Module	Q50L-SR-12	DC12V	110mA	<ul style="list-style-type: none"> · Material: PC · Protection ratings with assemble : IP65 · Product size: $\varnothing 50 \times 50$
		Q50L-SR-24	DC24V	110mA	
	Q50L-SA Amber LED Strobe Module	Q50L-SA-12	DC12V	110mA	
		Q50L-SA-24	DC24V	110mA	
	Q50L-SG Green LED Strobe Module	Q50L-SG-12	DC12V	110mA	
		Q50L-SG-24	DC24V	110mA	
	Q50L-SB Blue LED Strobe Module	Q50L-SB-12	DC12V	110mA	
		Q50L-SB-24	DC24V	110mA	
	Q50L-SC White LED Strobe Module	Q50L-SC-12	DC12V	110mA	
		Q50L-SC-24	DC24V	110mA	

· LED Revolving Flashing Module

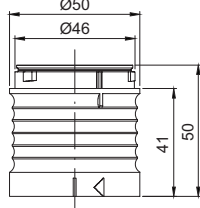

(Units : mm)

Layout	Parts Name	Model No	Specification		Common Specifications	
			Voltage	Current		
	Q50L-RR Red LED Revolving Flashing Module	Q50L-RR-12	DC12V	80mA	<ul style="list-style-type: none"> · Material: PC · Protection ratings with assemble : IP65 · Product size: $\varnothing 50 \times 50$ 	
		Q50L-RR-24	DC24V	80mA		
	Q50L-RA Amber LED Revolving Flashing Module	Q50L-RA-12	DC12V	80mA		
		Q50L-RA-24	DC24V	80mA		

Modular Multi-Functional LED Tower Lights

QT50 Series

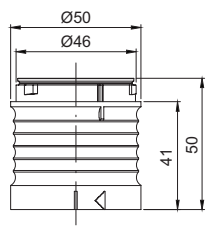
(Units : mm)

Layout	Parts Name	Model No	Specification		Common Specifications
			Voltage	Current	
	Q50L-RG Green LED Revolving Flashing Module	Q50L-RG-12 Q50L-RG-24	DC12V DC24V	80mA 80mA	<ul style="list-style-type: none"> Material: PC Protection ratings with assemble : IP65 Product size: Ø50 x 50 
	Q50L-RB Blue LED Revolving Flashing Module	Q50L-RB-12 Q50L-RB-24	DC12V DC24V	80mA 80mA	
	Q50L-RC White LED Revolving Flashing Module	Q50L-RC-12 Q50L-RC-24	DC12V DC24V	80mA 80mA	

• Buzzer module

(Units : mm)

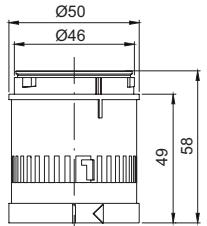
Layout	Parts Name	Model No	Specification		Common Specifications
			Voltage	Current	
	Q50L-BZ Buzzer module	Q50L-BZ-12 Q50L-BZ-24 Q50L-BZ-110 Q50L-BZ-220	DC12V DC24V AC110V AC220V	30mA 55mA 110mA 130mA	<ul style="list-style-type: none"> Material: PC Protection ratings with assemble: IP54 Product size: Ø50 x 58 Volume: Max.90dB 



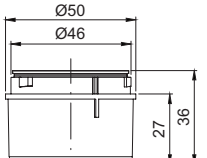

• Base Module

(Units : mm)

Layout	Parts Name	Model No	Common Specifications
	Pole Mount Base Module Direct Mount Base Module	Q50L-BS	<ul style="list-style-type: none"> Material: PC Protection ratings with assemble: IP65 Product size: Ø50 x 36 

• Mount Bracket Module

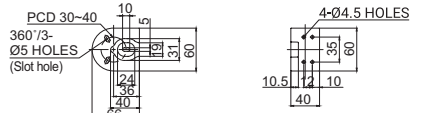
(Units : mm)

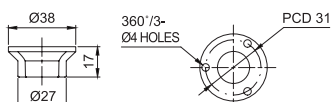
Layout	Parts Name	Model No	Material	Technical Diagram
	Wall mount Bracket	TWS45	Steel	
	Wall mount Bracket	TWA45	PC	
	Pole Module	Q50L-PB	PC	

Ø50mm Modular LED Tower Lights

QT50ML

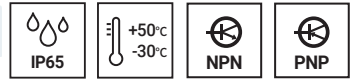

Product consist of cover, LED modules, base module

QT50ML Ø50mm Modular LED Tower Lights, Direct Mount

Model number	Layers	Voltage	Certificates	Weight	Color
QT50ML QT50MLF	1	DC12V	CE	0.10kg	● R-Red
		DC24V		0.10kg	
		AC110V		0.11kg	
		AC220V		0.11kg	
	2	DC12V		0.14kg	● R-Red
		DC24V		0.14kg	● G-Green
		AC110V		0.15kg	
		AC220V		0.15kg	
	3	DC12V		0.19kg	● R-Red
		DC24V		0.19kg	● A-Amber
AC110V		0.20kg	● G-Green		
AC220V		0.20kg			
4	DC12V	0.23kg	● R-Red		
	DC24V	0.23kg	● A-Amber		
	AC110V	0.24kg	● G-Green		
	AC220V	0.24kg	● B-Blue		
5	DC12V	0.27kg	● R-Red		
	DC24V	0.27kg	● A-Amber		
	AC110V	0.28kg	● G-Green		
	AC220V	0.28kg	● B-Blue ○ W-White		

※ CE compliant: DC12V, DC24V, AC220V



QT50ML

Beige color
Beige color is available



module configuration

QT50ML QT50MLF	Steady Module Steady/Flashing Module	+	Base Module(BS)
-------------------	---	---	-----------------

Light source current(based on 1 layer)

Voltage	DC12V	DC24V	AC110V	AC220V
Light source current(1 layer)	100mA	55mA	25mA	25mA

Wiring Instructions

- LED tower light can be wired by using transistor and External Contact

Customization

- Beige color
- LED Strobe(Model number: QT50MLS)
- LED simulated revolving(Model number: QT50MLR)
- Wall mount bracket options : Bracket structure allows for threading through the bracket hole or into the wall



Ordering Specifications

QT50ML	-	3	-	220	-	RAG
[Model number]		[Layers]		[Voltage]		[Color]
QT50ML		1-1 Layer		12-DC12V		● R-Red
QT50MLF		2-2 Layers		24-DC24V		● A-Amber
		3-3 Layers		110-AC110V		● G-Green
		4-4 Layers		220-AC220V		● B-Blue
		5-5 Layers				○ W-White

Technical Diagram

Units : mm

QT50ML

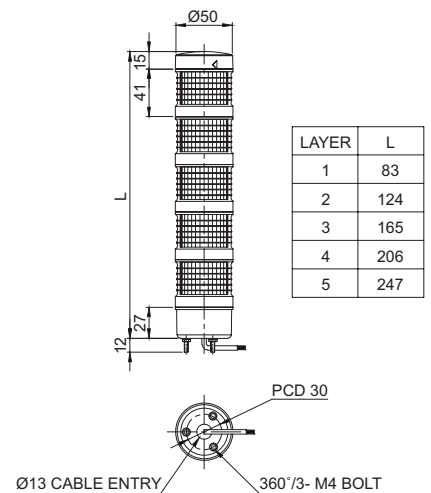

Ø50mm Built-in Buzzer Modular LED Tower Lights

QT50ML-BZ



Product consist of cover, LED modules, buzzer module, base module

QT50ML-BZ Ø50mm Built-in Buzzer Modular LED Tower Lights, Direct Mount



QT50ML-BZ

Beige color
Beige color is available



Model number	Layers	Voltage	Certificates	Weight	Color
QT50ML-BZ QT50MLF-BZ (Max. 90dB)	1	DC12V	CE	0.17kg	● R-Red
		DC24V		0.17kg	
		AC110V		0.18kg	
		AC220V		0.18kg	
	2	DC12V		0.21kg	● R-Red ● G-Green
		DC24V		0.21kg	
		AC110V		0.22kg	
		AC220V		0.22kg	
	3	DC12V		0.25kg	● R-Red ● A-Amber ● G-Green
		DC24V		0.25kg	
		AC110V		0.26kg	
		AC220V		0.26kg	
4	DC12V	0.30kg	● R-Red ● A-Amber ● G-Green ● B-Blue		
	DC24V	0.30kg			
	AC110V	0.31kg			
	AC220V	0.31kg			

※ CE compliant: DC12V, DC24V, AC220V

module configuration

QT50ML QT50MLF	Steady Module Steady/Flashing Module	+	Base Module(BS)	+	Buzzer module(BZ)
-------------------	--	---	-----------------	---	-------------------

Light source/buzzer current(based on 1 layer)

Voltage	DC12V	DC24V	AC110V	AC220V
Light source current(1 layer)	100mA	55mA	25mA	25mA
Buzzer current	30mA	55mA	110mA	130mA

Technical Diagram

Units : mm

QT50ML-BZ

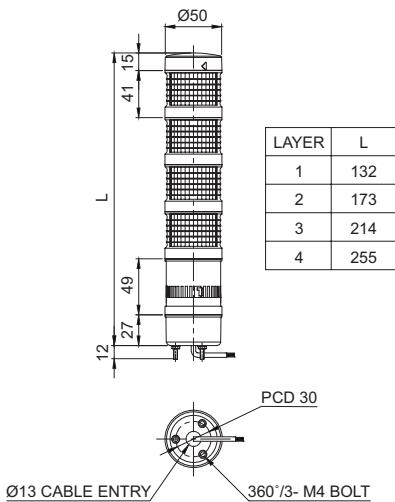

Wiring Instructions

- LED tower light can be wired by using transistor and External Contact

Customization

- Beige color
- LED Strobe(Model number: QT50MLS-BZ)
- LED simulated revolving(Model number: QT50MLR-BZ)
- Wall mount bracket options : Bracket structure allows for threading through the bracket hole or into the wall



Ordering Specifications

QT50ML-BZ	-	3	-	220	-	RAG
[Model number]		[Layers]		[Voltage]		[Color]
QT50ML-BZ		1-1 Layer		12-DC12V		● R-Red
QT50MLF-BZ		2-2 Layers		24-DC24V		● A-Amber
		3-3 Layers		110-AC110V		● G-Green
		4-4 Layers		220-AC220V		● B-Blue

Ø50mm Modular Multi-Functional LED Tower Lights

QT50L

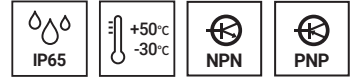

Product consist of cover, LED modules, base module, and pole module

QT50L Ø50mm Modular LED Tower Lights, Pole Mount

Model number	Layers	Voltage	Certificates	Weight	Color
QT50L QT50LF	1	DC12V	CE	0.25kg	● R-Red
		DC24V		0.25kg	
		AC110V		0.26kg	
		AC220V		0.26kg	
	2	DC12V		0.30kg	● R-Red
		DC24V		0.30kg	● G-Green
		AC110V		0.31kg	
		AC220V		0.31kg	
	3	DC12V		0.34kg	● R-Red
		DC24V		0.34kg	● A-Amber
		AC110V		0.35kg	● G-Green
		AC220V		0.35kg	
	4	DC12V		0.38kg	● R-Red
		DC24V		0.38kg	● A-Amber
		AC110V		0.39kg	● G-Green
		AC220V		0.39kg	● B-Blue
	5	DC12V		0.43kg	● R-Red
		DC24V		0.43kg	● A-Amber
		AC110V		0.44kg	● G-Green
		AC220V		0.44kg	● B-Blue ○ W-White

※ CE compliant: DC12V, DC24V, AC220V

module configuration

QT50L QT50LF	Steady Module Steady/Flashing Module	+	Base Module(BS) + Pole Module(PB)
-----------------	---	---	---

Light source current(based on 1 layer)

Voltage	DC12V	DC24V	AC110V	AC220V
Light source current(1 layer)	100mA	55mA	25mA	25mA

Wiring Instructions

· LED tower light can be wired by using transistor and External Contact

Mounting bracket

Standard	LB18	LW18	QZ18	SZ18	QL18	SL18
Steel	Steel	ABS	ABS	Al	ABS	Al

※ Please refer to [Tower Light Mounting bracket] on this catalogue for detailed dimensions

Ordering Specifications

QT50L	-	3	-	24	-	RAG	-	LW18
[Model number]		[Layers]		[Voltage]		[Color]		[Bracket]
QT50L		1-1 Layer		12-DC12V		● R-Red		· None-Standard
QT50LF		2-2 Layers		24-DC24V		● A-Amber		· Bracket
		3-3 Layers		110-AC110V		● G-Green		-LB18 -LW18
		4-4 Layers		220-AC220V		● B-Blue		-QZ18 -SZ18
		5-5 Layers				○ W-White		-QL18 -SL18



QT50L



Beige color

Beige color is available

Technical Diagram

Units : mm

·QT50L

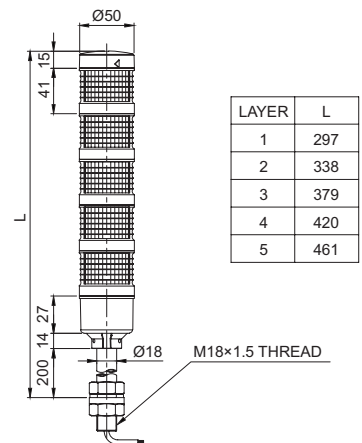

Customization

- Customized pole length available
- Beige color
- LED Strobe(Model number: QT50LS)
- LED simulated revolving (Model number: QT50LR)

Ø50mm Built-in Buzzer Modular Multi-Functional LED Tower Lights

QT50L-BZ



Product consist of cover, LED modules, buzzer module, base module, and pole module

QT50L-BZ Ø50mm Built-in Buzzer Modular LED Tower Lights, Pole Mount



QT50L-BZ

Beige color
Beige color is available



Technical Diagram

Units : mm

QT50L-BZ

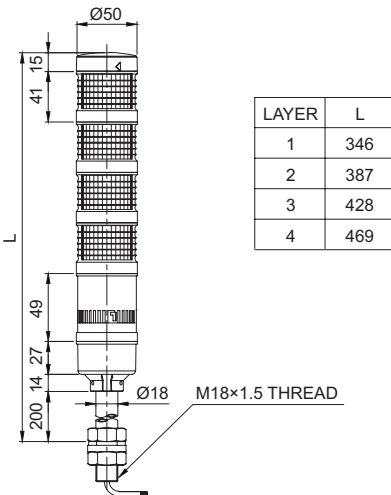

Customization

- Customized pole length available
- Beige color
- LED Strobe(Model number: QT50LS-BZ)
- LED simulated revolving (Model number: QT50LR-BZ)

Model number	Layers	Voltage	Certificates	Weight	Color
QT50L-BZ QT50LF-BZ	1	DC12V	CE	0.32kg	● R-Red
		DC24V		0.32kg	
		AC110V		0.33kg	
		AC220V		0.33kg	
2	DC12V	CE	0.37kg	● R-Red ● G-Green	
	DC24V		0.37kg		
	AC110V		0.38kg		
	AC220V		0.38kg		
3	DC12V	CE	0.41kg	● R-Red ● A-Amber ● G-Green	
	DC24V		0.41kg		
	AC110V		0.42kg		
	AC220V		0.42kg		
4	DC12V	CE	0.45kg	● R-Red ● A-Amber ● G-Green ● B-Blue	
	DC24V		0.45kg		
	AC110V		0.46kg		
	AC220V		0.46kg		

※ CE compliant: DC12V, DC24V, AC220V

module configuration

QT50L QT50LF	Steady Module Steady/Flashing Module	+	Base Module(BS) + Pole Module(PB)	+	Buzzer module(BZ)
-----------------	--	---	---	---	-------------------

Light source/buzzer current(based on 1 layer)

Voltage	DC12V	DC24V	AC110V	AC220V
Light source current(1 layer)	100mA	55mA	25mA	25mA
Buzzer current	30mA	55mA	110mA	130mA

Wiring Instructions

- LED tower light can be wired by using transistor and External Contact

Mounting bracket

Standard	LB18	LW18	QZ18	SZ18	QL18	SL18
Steel	Steel	ABS	ABS	Al	ABS	Al

※ Please refer to [Tower Light Mounting bracket] on this catalogue for detailed dimensions

Ordering Specifications

QT50L-BZ	-	3	-	24	-	RAG	-	LW18
[Model number]		[Layers]		[Voltage]		[Color]		[Bracket]
QT50L-BZ		1-1 Layer		12-DC12V		● R-Red		· None-Standard
QT50LF-BZ		2-2 Layers		24-DC24V		● A-Amber		· Bracket
		3-3 Layers		110-AC110V		● G-Green		-LB18 -LW18
		4-4 Layers		220-AC220V		● B-Blue		-QZ18 -SZ18
								-QL18 -SL18

Modular Multi-Functional LED Tower Lights

QT70 Series





Module Specifications QT70L / QT70ML

(Units : mm)

Layout	Parts Name	Model No	Common Specifications
	QT70L Cover	Q70L-CV	<ul style="list-style-type: none"> · Material: PC · Protection ratings with assemble: IP65 · Product size: Ø70 x 15 

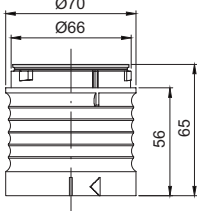

· LED Steady Module

(Units : mm)

Layout	Parts Name	Model No	Specification		Common Specifications
			Voltage	Current	
	Q70L-NR Red LED Steady Module	Q70L-NR-12 Q70L-NR-24 Q70L-NR-110 Q70L-NR-220	DC12V DC24V AC110V AC220V	120mA 55mA 25mA 25mA	<ul style="list-style-type: none"> · Material: PC · Protection ratings with assemble : IP65 · Product size: Ø70 x 65 
	Q70L-NA Amber LED Steady Module	Q70L-NA-12 Q70L-NA-24 Q70L-NA-110 Q70L-NA-220	DC12V DC24V AC110V AC220V	120mA 55mA 25mA 25mA	
	Q70L-NG Green LED Steady Module	Q70L-NG-12 Q70L-NG-24 Q70L-NG-110 Q70L-NG-220	DC12V DC24V AC110V AC220V	120mA 55mA 25mA 25mA	
	Q70L-NB Blue LED Steady Module	Q70L-NB-12 Q70L-NB-24 Q70L-NB-110 Q70L-NB-220	DC12V DC24V AC110V AC220V	120mA 55mA 25mA 25mA	
	Q70L-NC White LED Steady Module	Q70L-NC-12 Q70L-NC-24 Q70L-NC-110 Q70L-NC-220	DC12V DC24V AC110V AC220V	120mA 55mA 25mA 25mA	

· LED Flashing Module

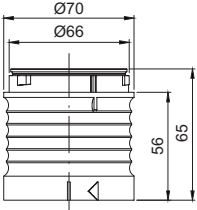

(Units : mm)

Layout	Parts Name	Model No	Specification		Common Specifications
			Voltage	Current	
	Q70L-FR Red LED Steady/Flashing Module	Q70L-FR-12 Q70L-FR-24 Q70L-FR-110 Q70L-FR-220	DC12V DC24V AC110V AC220V	120mA 55mA 25mA 25mA	<ul style="list-style-type: none"> · Material: PC · Protection ratings with assemble : IP65 · Product size: Ø70 x 65 
	Q70L-FA Amber LED Steady/Flashing Module	Q70L-FA-12 Q70L-FA-24 Q70L-FA-110 Q70L-FA-220	DC12V DC24V AC110V AC220V	120mA 55mA 25mA 25mA	
	Q70L-FG Green LED Steady/Flashing Module	Q70L-FG-12 Q70L-FG-24 Q70L-FG-110 Q70L-FG-220	DC12V DC24V AC110V AC220V	120mA 55mA 25mA 25mA	

Modular Multi-Functional LED Tower Lights



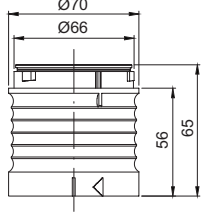

QT70 Series

(Units : mm)

Layout	Parts Name	Model No	Specification		Common Specifications
			Voltage	Current	
	Q70L-FB Blue LED Steady/Flashing Module	Q70L-FB-12	DC12V	120mA	<ul style="list-style-type: none"> · Material: PC · Protection ratings with assemble: IP65 · Product size: Ø70 x 65
		Q70L-FB-24	DC24V	55mA	
		Q70L-FB-110	AC110V	25mA	
		Q70L-FB-220	AC220V	25mA	
	Q70L-FC White LED Steady/Flashing Module	Q70L-FC-12	DC12V	120mA	
		Q70L-FC-24	DC24V	55mA	
		Q70L-FC-110	AC110V	25mA	
		Q70L-FC-220	AC220V	25mA	



· LED Strobe Module

(Units : mm)



Layout	Parts Name	Model No	Specification		Common Specifications
			Voltage	Current	
	Q70L-SR Red LED Strobe Module	Q70L-SR-12	DC12V	120mA	<ul style="list-style-type: none"> · Material: PC · Protection ratings with assemble: IP65 · Product size: Ø70 x 65
		Q70L-SR-24	DC24V	120mA	
	Q70L-SA Amber LED Strobe Module	Q70L-SA-12	DC12V	120mA	
		Q70L-SA-24	DC24V	120mA	
	Q70L-SG Green LED Strobe Module	Q70L-SG-12	DC12V	120mA	
		Q70L-SG-24	DC24V	120mA	
	Q70L-SB Blue LED Strobe Module	Q70L-SB-12	DC12V	120mA	
		Q70L-SB-24	DC24V	120mA	
	Q70L-SC White LED Strobe Module	Q70L-SC-12	DC12V	120mA	
		Q70L-SC-24	DC24V	120mA	

· LED Revolving Flashing module

(Units : mm)

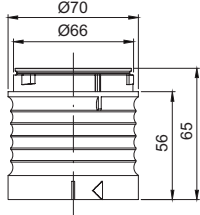

Layout	Parts Name	Model No	Specification		Common Specifications
			Voltage	Current	
	Q70L-RR Red LED Revolving Flashing Module	Q70L-RR-12	DC12V	80mA	<ul style="list-style-type: none"> · Material: PC · Protection ratings with assemble: IP65 · Product size: Ø70 x 65
		Q70L-RR-24	DC24V	80mA	
	Q70L-RA Amber LED Revolving Flashing Module	Q70L-RA-12	DC12V	80mA	
		Q70L-RA-24	DC24V	80mA	

(Units : mm)

Layout	Parts Name	Model No	Specification		Common Specifications
			Voltage	Current	
	Q70L-RG Green LED Revolving Flashing Module	Q70L-RG-12 Q70L-RG-24	DC12V DC24V	80mA 80mA	<ul style="list-style-type: none"> · Material: PC · Protection ratings with assemble: IP65 · Product size: $\varnothing 70$ x 65 
	Q70L-RB Blue LED Revolving Flashing Module	Q70L-RB-12 Q70L-RB-24	DC12V DC24V	80mA 80mA	
	Q70L-RC White LED Revolving Flashing Module	Q70L-RC-12 Q70L-RC-24	DC12V DC24V	80mA 80mA	

· Buzzer module

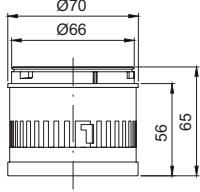
(Units : mm)

Layout	Parts Name	Model No	Specification		Common Specifications
			Voltage	Current	
	Q70L-BZ Buzzer module	Q70L-BZ-12 Q70L-BZ-24 Q70L-BZ-110 Q70L-BZ-220	DC12V DC24V AC110V AC220V	30mA 55mA 110mA 130mA	<ul style="list-style-type: none"> · Material: PC · Protection ratings with assemble: IP54 · Product size: $\varnothing 70$ x 65 · Volume: Max. 90dB 
	Q70L-BZS Siren Buzzer module	Q70L-BZS-12 Q70L-BZS-24 Q70L-BZS-110 Q70L-BZS-220	DC12V DC24V AC110V AC220V	240mA 150mA 10mA 20mA	

QT70 Series





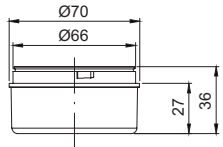

• Base Module

(Units : mm)

Layout	Parts Name	Model No	Common Specifications
	Base Module	Q70L-BS	<ul style="list-style-type: none"> Material: PC Protection ratings with assemble: IP65 Product size: $\varnothing 70 \times 36$ 

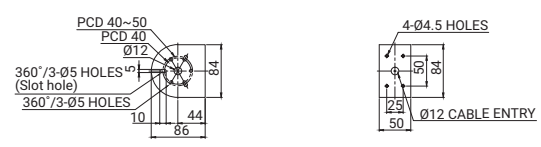
• Mount Bracket Module(Built-in Sounder)

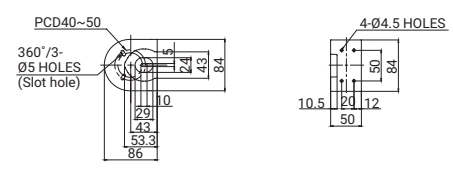
(Units : mm)

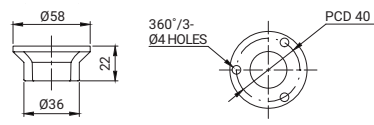
Layout	Parts Name	Model No	Material	Technical Diagram
	Wall Mount Bracket	TWS80	Steel	
	Wall Mount Bracket	TWA80	PC	
	Pole Module	Q70L-PB	PC	

Ø70mm Modular Multi-Functional LED Tower Lights

QT70ML

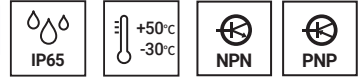

Product consist of cover, LED modules, signal sound module, base module

QT70ML Ø70mm Direct Mount Modular LED Tower Lights

Model number	Layers	Voltage	Certificates	Weight	Color
QT70ML QT70MLF	1	DC12V	CE	0.17kg	● R-Red
		DC24V		0.17kg	
		AC110V		0.18kg	
		AC220V		0.18kg	
	2	DC12V		0.25kg	● R-Red
		DC24V		0.25kg	● G-Green
		AC110V		0.26kg	
		AC220V		0.26kg	
	3	DC12V		0.32kg	● R-Red
		DC24V		0.32kg	● A-Amber
		AC110V		0.33kg	● G-Green
		AC220V		0.33kg	
	4	DC12V		0.40kg	● R-Red
		DC24V		0.40kg	● A-Amber
		AC110V		0.41kg	● G-Green
		AC220V		0.41kg	● B-Blue
	5	DC12V		0.47kg	● R-Red
		DC24V		0.47kg	● A-Amber
		AC110V		0.48kg	● G-Green
		AC220V		0.48kg	● B-Blue ○ W-White

※ CE compliant: DC12V, DC24V



QT70ML

Beige color

Beige color is available



module configuration

QT70ML QT70MLF	Steady Module Steady/Flashing Module	+	Base Module(BS)
-------------------	---	---	-----------------

Light source current(based on 1 layer)

Voltage	DC12V	DC24V	AC110V	AC220V
Light source current(1 layer)	120mA	55mA	25mA	25mA

Wiring Instructions

· LED tower light can be wired by using transistor and external contact

Customization

- Beige color
- LED Strobe(Model number: QT70MLS)
- LED simulated revolving(Model number: QT70MLR)
- Wall mount bracket options : Bracket structure allows for threading through the bracket hole or into the wall

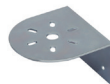

Wall mount bracket TWS80



Wall mount bracket TWA80

Ordering Specifications

QT70ML	-	3	-	220	-	RAG
[Model number]		[Layers]		[Voltage]		[Color]
QT70ML		1-1 Layer		12-DC12V		● R-Red
QT70MLF		2-2 Layers		24-DC24V		● A-Amber
		3-3 Layers		110-AC110V		● G-Green
		4-4 Layers		220-AC220V		● B-Blue
		5-5 Layers				○ W-White

Technical Diagram

Units : mm

·QT70ML

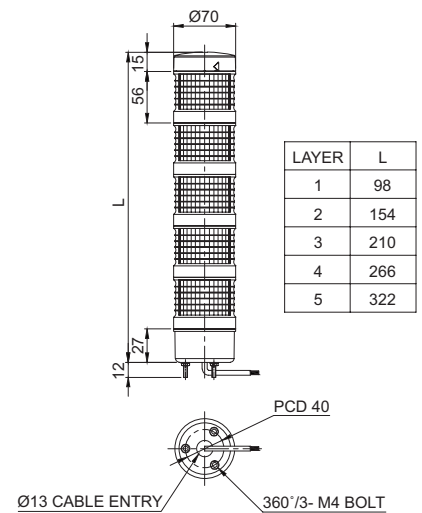

Ø70mm Modular Multi-Functional LED Tower Lights

QT70L

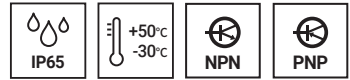

Product consist of cover, LED modules, base module, and pole module

QT70L Ø70mm Pole Mount Modular LED Tower Lights

Model number	Layers	Voltage	Certificates	Weight	Color
QT70L QT70LF	1	DC12V	CE	0.41kg	● R-Red
		DC24V		0.41kg	
		AC110V		0.42kg	
		AC220V		0.42kg	
	2	DC12V		0.48kg	● R-Red
		DC24V		0.48kg	● G-Green
		AC110V		0.49kg	
		AC220V		0.49kg	
	3	DC12V		0.55kg	● R-Red
		DC24V		0.55kg	● A-Amber
		AC110V		0.56kg	● G-Green
		AC220V		0.56kg	
	4	DC12V		0.63kg	● R-Red
		DC24V		0.63kg	● A-Amber
		AC110V		0.64kg	● G-Green
		AC220V		0.64kg	● B-Blue
	5	DC12V		0.71kg	● R-Red
		DC24V		0.71kg	● A-Amber
		AC110V		0.72kg	● G-Green
		AC220V		0.72kg	● B-Blue ○ W-White

※ CE compliant: DC12V, DC24V



QT70L

Beige color
Beige color is available



module configuration

QT70L QT70LF	Steady Module Steady/Flashing Module	+	Base Module(BS) + Pole Module(PB)
-----------------	---	---	---

Light source current(based on 1 layer)

Voltage	DC12V	DC24V	AC110V	AC220V
Light source current(1 layer)	120mA	55mA	25mA	25mA

Wiring Instructions

· LED tower light can be wired by using transistor and External Contact

Mounting bracket

Standard	LB24	LW24	QZ24	SZ24	QL24	SL24
Steel	Steel	ABS	ABS	Al	ABS	Al

※ Please refer to [Tower Light Mounting bracket] on this catalogue for detailed dimensions

Ordering Specifications

QT70L	-	3	-	24	-	RAG	-	LW24
[Model number]		[Layers]		[Voltage]		[Color]		[Bracket]
QT70L QT70LF		1-1 Layer 2-2 Layers 3-3 Layers 4-4 Layers 5-5 Layers		12-DC12V 24-DC24V 110-AC110V 220-AC220V		● R-Red ● A-Amber ● G-Green ● B-Blue		· None-Standard · Bracket · LB24-LW24 · QZ24-SZ24 · QL24-SL24

Technical Diagram

Units : mm

· QT70L

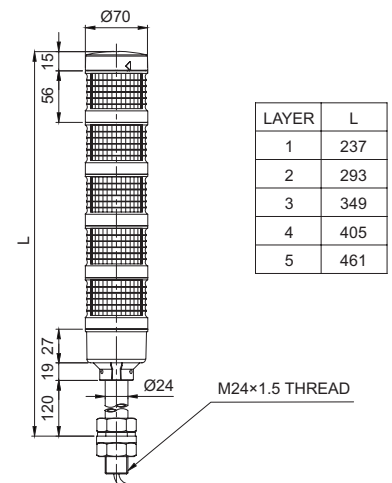

Customization

- Customized pole length available
- Beige color
- LED Strobe(Model number: QT70LS)
- LED simulated revolving (Model number: QT70LR)

Ø70mm Multi-Functional Modular LED Tower Lights with Buzzer

QT70L-BZ



Product consist of cover, LED modules, buzzer module, base module, and pole module

QT70L-BZ Ø70mm Pole Mount Modular LED Tower Lights with Buzzer



QT70L-BZ

Beige color
Beige color is available



Model number	Layers	Voltage	Certificates	Weight	Color
QT70L-BZ QT70LF-BZ (Max. 90dB)	1	DC12V DC24V AC110V AC220V	CE	0.50kg 0.50kg 0.51kg 0.51kg	R-Red
	2	DC12V DC24V AC110V AC220V		0.58kg 0.88kg 0.59kg 0.59kg	R-Red G-Green
	3	DC12V DC24V AC110V AC220V		0.65kg 0.65kg 0.66kg 0.66kg	R-Red A-Amber G-Green
	4	DC12V DC24V AC110V AC220V		0.73kg 0.73kg 0.74kg 0.74kg	R-Red A-Amber G-Green B-Blue

※ CE compliant: DC12V, DC24V

module configuration

QT70L QT70LF	Steady Module Steady/Flashing Module	+	Base Module(BS) + Pole Module(PB)	+	Buzzer module(BZ)
-----------------	--	---	---	---	-------------------

Light source/buzzer current(based on 1 layer)

Voltage	DC12V	DC24V	AC110V	AC220V
Light source current(1 layer)	120mA	55mA	25mA	25mA
Buzzer current	30mA	55mA	110mA	130mA

Wiring Instructions

· LED tower light can be wired by using transistor and external contact

Customization

- Customized pole length available
- Beige color
- LED Strobe(Model number: QT70LS-BZ)
- LED simulated revolving(Model number: QT70LR-BZ)

Technical Diagram

Units : mm

·QT70L-BZ

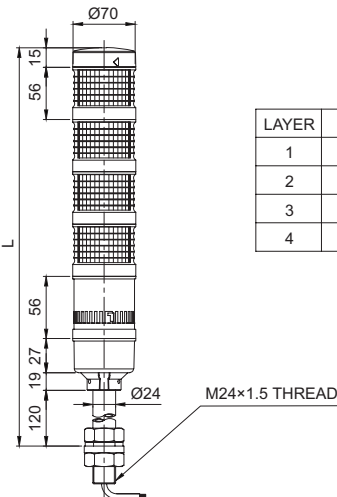

Mounting bracket

Standard	LB24	LW24	QZ24	SZ24	QL24	SL24
Steel	Steel	ABS	ABS	Al	ABS	Al

※ Please refer to [Tower Light Mounting bracket] on this catalogue for detailed dimensions

Ordering Specifications

QT70L-BZ	-	3	-	24	-	RAG	-	LW24
[Model number]		[Layers]		[Voltage]		[Color]		[Bracket]
QT70L-BZ		1-1 Layer		12-DC12V		R-Red		· None-Standard
QT70LF-BZ		2-2 Layers		24-DC24V		A-Amber		· Bracket
		3-3 Layers		110-AC110V		G-Green		-LB24 -LW24
		4-4 Layers		220-AC220V		B-Blue		-QZ24 -SZ24
								-QL24 -SL24

QT Series

Wiring Instructions(Wiring using External Contact)

- QT Series can be wired by using both External Contact and transistor.
- In case of wiring with External Contacts, refer to the wiring diagrams below according to your product's type and voltage setting.

Wiring instructions

DC/AC standard

- QT50ML(F)
- QT50MLS(DC only)
- QT50MLR(DC only)
- QT50L(F)
- QT50LS(DC only)
- QT50LR(DC only)
- QT70ML(F)
- QT70MLS(DC only)
- QT70MLR(DC only)
- QT70L(F)
- QT70LS(DC only)
- QT70LR(DC only)

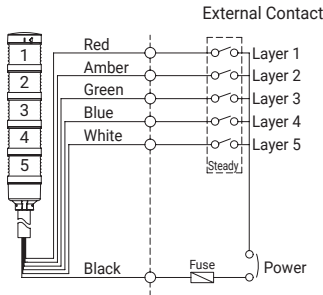

Wiring instructions

DC/AC buzzer

- QT50ML(F)-BZ
- QT50MLS-BZ(DC only)
- QT50MLR-BZ(DC only)
- QT50L(F)-BZ
- QT50LS-BZ(DC only)
- QT50LR-BZ(DC only)
- QT70ML(F)-BZ
- QT70MLS-BZ(DC only)
- QT70MLR-BZ(DC only)
- QT70L(F)-BZ
- QT70LS-BZ(DC only)
- QT70LR-BZ(DC only)

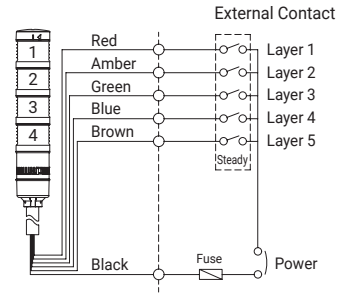

Wiring Instructions(Wiring using transistor)

- In case of wiring by transistor, please make sure if it is NPN type or PNP type. Please carefully follow wiring instruction below.

Wiring instructions

DC standard

- QT50ML(F)
- QT50MLS
- QT50MLR
- QT50L(F)
- QT50LS
- QT50LR
- QT70ML(F)
- QT70MLS
- QT70MLR
- QT70L(F)
- QT70LS
- QT70LR

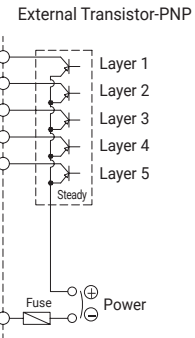
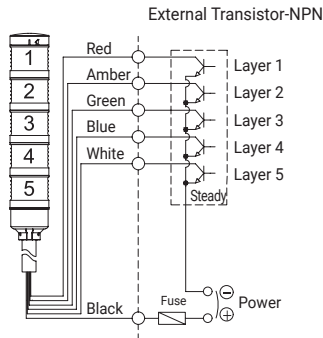

DC buzzer

- QT50ML(F)-BZ
- QT50MLS-BZ
- QT50MLR-BZ
- QT50L(F)-BZ
- QT50LS-BZ
- QT50LR-BZ
- QT70ML(F)-BZ
- QT70MLS-BZ
- QT70MLR-BZ
- QT70L(F)-BZ
- QT70LS-BZ
- QT70LR-BZ

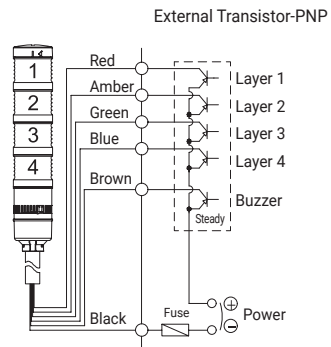
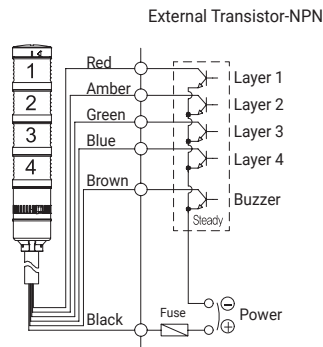

- DC steady/flashing type cable specification: External signal line - UL1007 AWG22(0.3sq) 400mm.
- AC steady/flashing type cable specification: External signal line - UL1007 AWG22(0.3sq) 400mm