

# Q80L Series



Q80L



Q80LW

## PRODUCT SPECIFICATION

Q80L | Q80LW | Q80LP

**Materials** Lens-PC, housing-ABS, mounting bracket-PC

**Ambient operating temperature** -30°C to +50°C

**Volume** Max.80dB at 1m



**Protection rating** IP65

**Flashing rate** 60-80/min

**Compliant with RoHS directive**

- Small-sized signal light of Ø80mm with attractive appearance
- Shock and vibration-resistant, maintenance reduced with long-lasting energy-efficient LED light bulb
- Selectable mounts available depending on your application environment(direct mount, wall mount, pole mount)
- Features high visibility with special diffusive lens and direct LED light distribution system
- Built-in switch for selection between steady and flashing light mode
- Can select between standard and built-in buzzer type depending on installation environment

### Q80L / Q80LW / Q80LP LED Steady/Flashing Signal Light

Model number	Voltage	Current	Certificates	Weight	Color
Q80L	DC12V-24V	Max.205mA	 	Q80L-0.21kg	<ul style="list-style-type: none"> <li><span style="color: red;">●</span> R-Red</li> <li><span style="color: yellow;">●</span> A-Amber</li> <li><span style="color: green;">●</span> G-Green</li> <li><span style="color: blue;">●</span> B-Blue</li> </ul>
Q80LW				Q80LW-0.25kg	
Q80LP			Q80LP-0.40kg		
	AC110V-220V	Max.65mA	(Including buzzer and standard pipe)		







- Various mounting options are available
- ※ DC type model has a free-voltage range of 10V-30V.
- ※ AC type model has a free-voltage range of 100V-240V.
- ※ UL Listed: DC24V

### Wiring Instructions

- External Power line - UL1015 AWG18(0.75sq) x 2C 400mm
- This product can be wired regardless of polarity.

**Customization** · Customized pole length available

### Mounting Bracket

Standard	LB24	LW24	QZ24	SZ24	QL24	SL24
						
Steel	Steel	ABS	ABS	Al	ABS	Al

Please refer to [Tower Light Mounting Bracket] on this catalogue for detailed dimensions.



## Technical Diagram

Units: mm

·Q80L

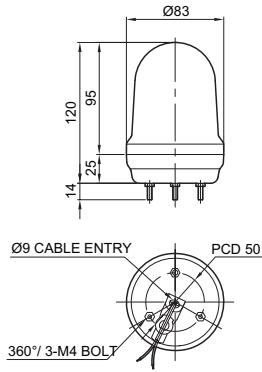

·Q80LP

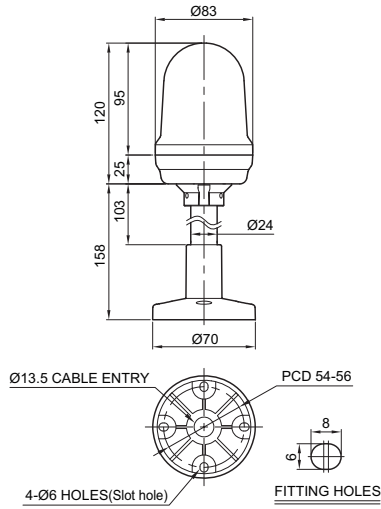

·Q80LW

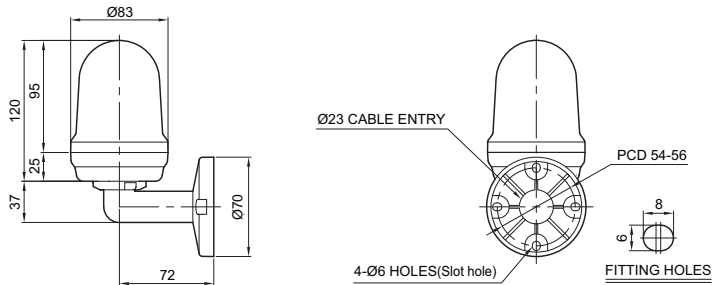

**Q80LP**  
(SZ24 Bracket)

## Ordering Specification

<b>Q80LP</b>	-	<b>BZ</b>	-	<b>12/24</b>	-	<b>R</b>	-	<b>QZ24</b>
[Model number]		[Buzzer option]		[Voltage]		[Color]		[mount bracket]
Q80L Q80LW Q80LP		(None) - No buzzer BZ - Built-in buzzer		12/24-DC12V-24V 110/220-AC110V-220V		● R-Red ● A-Amber ● G-Green ● B-Blue		(None) - Standard Bracket -LB24-LW24 -QZ24-SZ24 -QL24-SL24