

Signal Tower Light With Built-In Audible Signal

STB45ML-NEC

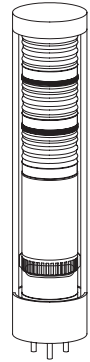

Thank you for purchasing Qlight's products. Please read this user manual carefully prior to installation and operation to ensure safe and correct use.

Safety Precautions for Explosion Proof Products

Please follow the instruction below to ensure safe and correct use of explosion proof products.

1. Explosion proof products should be managed according to explosion-proof regulations. Do not disassemble, assemble, alter or repair the product arbitrarily.
2. The temperature rating of the product is the temperature the product will experience at the applied rated voltage and ambient temperature indicated.
3. Use cable glands that satisfy the product's explosion proof grade and temperature grade.
4. Unused cable entries must be filled with material that meets the explosion proof grade and temperature rating.
5. Before installing the product, please make sure all cautions indicated on the labels, packaging, and operation manual of the product are fully understood.
6. Installation, maintenance and repair of the product must be performed by experts in the explosion proof field, or persons who have received relevant training.
7. For safety, the product should be installed and operated in environments that avoid high temperature and high pressure.
8. Please follow general safety precautions and avoid installing the product in locations that may generate excessive heat.
9. When installing the product in places where chemicals are located, please make sure that the environment does not have two or more incompatible chemicals mixed. For safety, please read the instruction manual carefully and be mindful of the chemical compositions where the product is used.
10. This product requires grounding.
11. The equipment shall be supplied by an appropriately rated transient protective device that is set to a level not exceeding 140% of the peak rated voltage.
12. The use of the isolating source and ratings of the overcurrent protective device(3 Amps as per 22AWG) required to be installed in the field.

Specific conditions of use

1. The equipment enclosure shall not be opened when an explosive atmosphere is present and shall be used in an area of at least Pollution degree 2 as defined in IEC 60664-1.
2. The equipment shall be supplied by an appropriately rated transient protective device that is set to a level not exceeding 140% of the peak rated voltage.
3. The equipment includes external non-metallic parts. the user shall therefore ensure that the equipment is not installed in a location where it may be subjected to external conditions which might cause a build-up of electrostatic charges on non-conducting surfaces. Additionally, cleaning of the equipment shall be done with a damp cloth.
4. External earthing connection shall be established by end-user via prepared M4 bolt and cable with a diameter greater than 4mm². External earthing connection shall be corrosion resist.
5. The equipment shall be installed so as to be protected from mechanical impact.

Precaution for Safety

Failure to follow the instructions below may cause a loss of life or serious physical injury.

1. During wiring or maintenance, please completely turn off the power of the product. (Failure to follow this may lead to an electric shock.)
2. Do not install the product in locations that subjects it to excessive dust or water other than the conditions designated by the IP protection ratings indicated for each product. (Failure to follow these instructions may cause a fire to the product, electric shock, physical injury, malfunction or damage to the product.)
3. Do not alter or repair this product. If maintenance or repair service is required, please contact your local Qlight contact point. (Failure to follow these instructions may lead to fire, electric shock, or product damage.)
4. Please apply the correct voltage to the product. (Failure to follow these instructions may lead to fire, electric shock, or product damage.)
5. When the product is applied to a condition that may impact lives or property, please make sure to have a double safety device. (Failure to follow this may cause damage to property, fire, electric shock and loss of life.)

Failure to follow the proper instructions may cause damage to property, the product, or malfunction of the product that would void the warranty.

1. Please remove any objects that can interrupt ventilation around the product.
2. Please turn off the power of the product immediately if it fails to operate properly.
3. Carefully wire the product according to each product's specification.
4. Please be careful in preventing chemicals such as thinner, benzene, etc. in contact with the surface of the product.
5. Do not apply excessive force/impact to the product.
6. Static electricity may be generated by physical contact due to the surface characteristics of this product so please use a wet towel or anti-static cleaner to remove the foreign substances on the product.



Please scan the QR code for more detailed product information.

www.qlight.com

Ordering Specifications

STB45ML-NEC	-	3	-	24	-	RAG
[Model number]		[Layer]		[Voltage]		[Color]
• STB45ML-NEC		• Layer3-3		• 24-DC24V		R-Red A-Amber G-Green

Product Specifications

Explosion Proof Specifications

Model number	STB45ML-NEC
Range for operating voltage	DC24V
Ex mark	Class I, Zone 2, AEx ec IIC T6 Gc Class I, Division 2 Groups ABCD T6
Ambient operating temperature	-20°C ≤ Tamb ≤ +40°C
Explosion proof Zone	Class I, Zone 2, Class I, Division 2
Protection rating	IP54
Applicable standards	UL 60079-0 UL 60079-7 UL 508

General Product Specification

Model number	Layer	Voltage	Certificates	Weight	Color
STB45ML-NEC	3	DC24V		0.40kg	R-Red A-Amber G-Green

Light source/buzzer current(based on 1 layer)

Voltage condition	DC24V
Light source current (1 layer)	12mA
Buzzer current	40mA

Dimensions

(Units : mm)

STB45ML-NEC

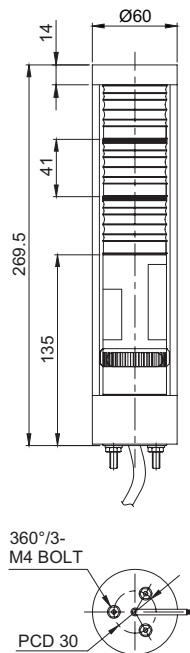

Wiring Instructions

- STB45ML-NEC can be wired by using both external contact and transistor.
- In case of wiring by transistor, please make sure if it is NPN type or PNP type. Please carefully follow wiring instruction below.

STB45ML-NEC-DC

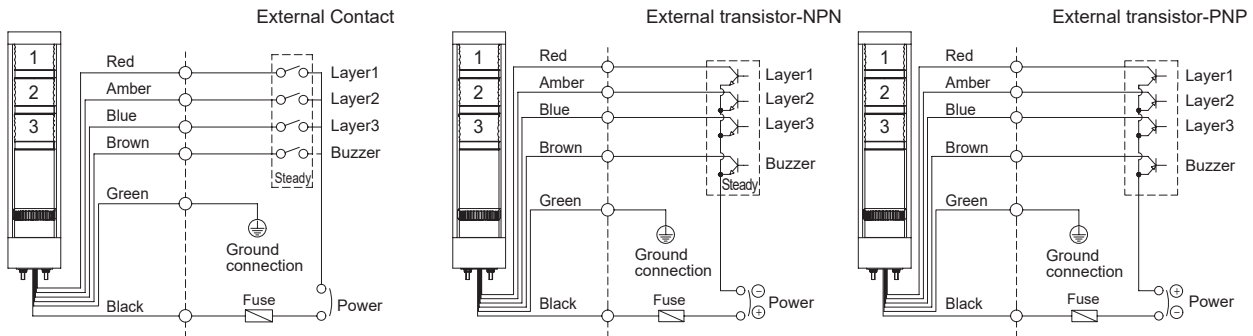

- External power line/ external signal line - LAPP UNITRONIC 300
- This product can be wired regardless of polarity.

Parts Definition/ Installation

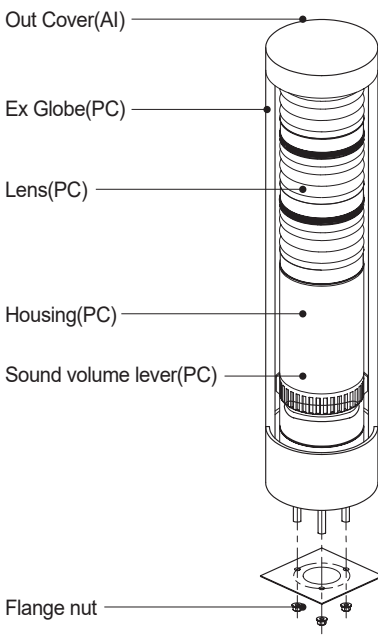

- First, remove the flange nuts from bolts and place the product through the mounting surface holes.
- Fasten the flange nuts on the opposite side of the mounting surface until the product is tightened securely.

Mounting Hole Specifications

- Machine holes on the mounting surface referring to the diagram below.

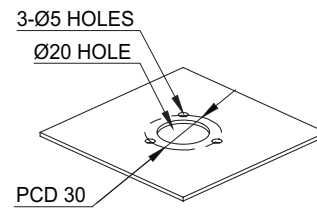

Grounding Instructions

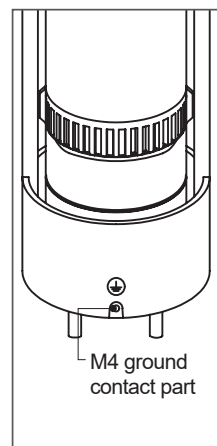

- Please use an M4 bolt at the location marked in the diagram above to ground the product.
- When connecting the grounding cable, please use a ring terminal.
- Please use a ring terminal made of C5212 material as it has the same electrical properties of the conductor.
- Please use a grounding cable with a diameter greater than 4mm².
- Internal grounding terminal shall be used for the equipment grounding connection and that the external terminal is for a supplementary bonding connection where local codes or authorities permit Buzzer Sound Volume Adjustment Instructions or require such connection.

Buzzer Sound Volume Adjustment Instructions

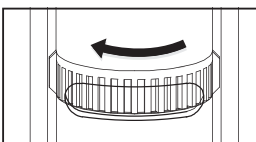

Buzzer volume is reduced by sliding the volume control lever to the left as shown in the diagram to the left. (Min. 65dB/m)

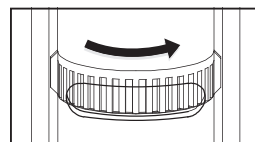

Raise/ Increase the buzzer volume by sliding the control lever to the right as shown in the diagram to the left. (Max. 83dB/m)

Installation environment

- To protect the cables pulled out, the product must be installed directly in the enclosure and used by wiring inside the installed enclosure.

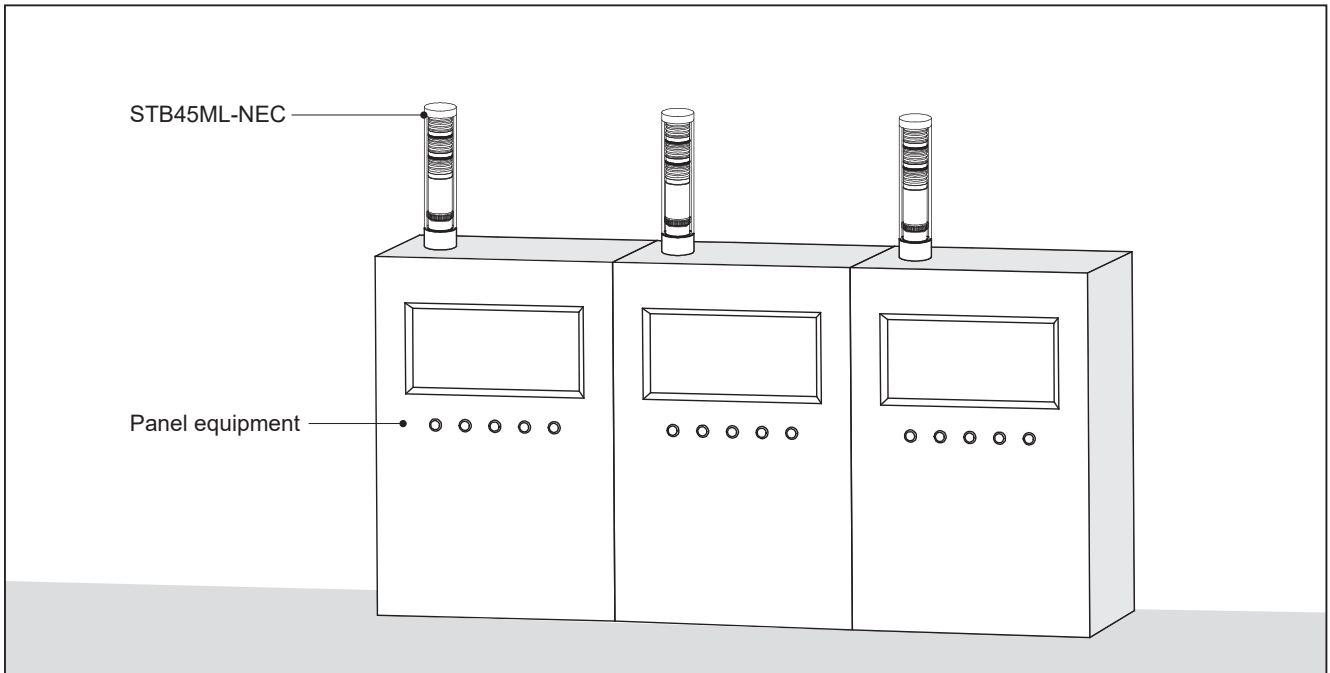

Installation Environment and Protection Rating

- This product is designed to be explosion proof.
- Please make sure to use the product in an environment that meets the specified explosion proof rating and regulations.
- For further information, please visit our website (www.qlight.com).

Product installation direction

- Install the product in accordance with the manual. Otherwise rainwater or moisture may penetrate into the product.

· BEACON/SIGNALING LIGHT

※ For products with a protection rating of less than IPX4, please install it vertically.

Power cord inlet part shall not be facing the sky.

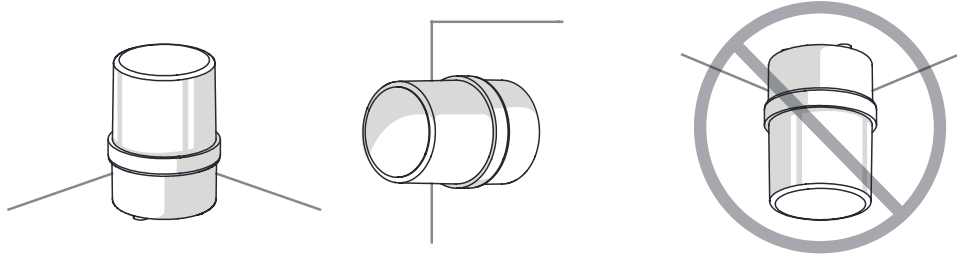

· ELECTRONIC SOUNDER/SIGNAL HORN

Sounder part shall not be facing the sky.

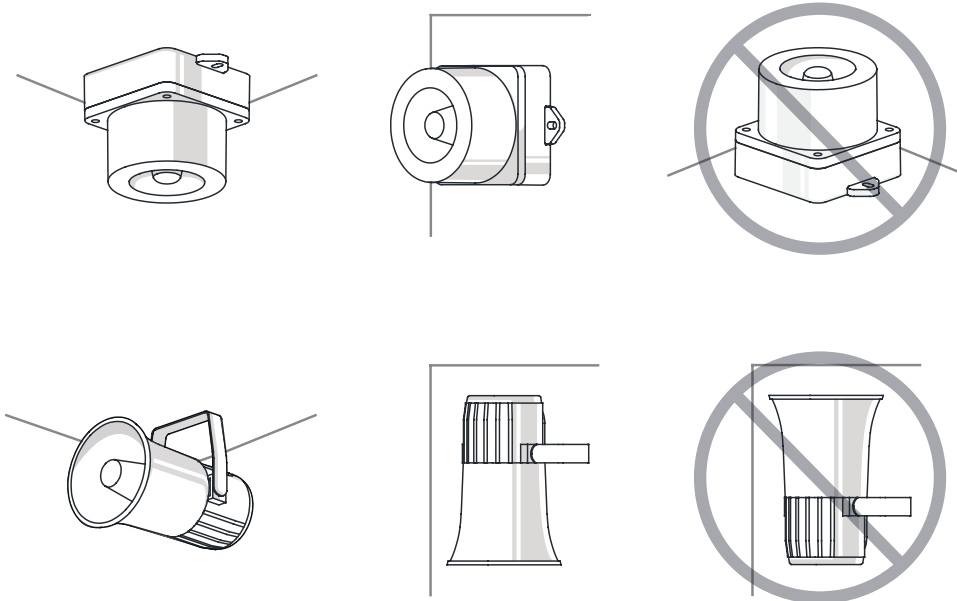

· HEAVY-DUTY & EXPLOSION PROOF SIGNALINGS

Sounder part shall not be facing the sky.

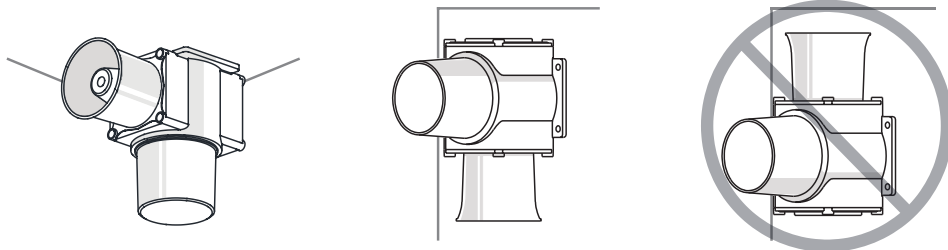

· SIGNAL TOWER LIGHTS

※ For products with a protection rating of less than IPX4, please install it vertically.

Power cord inlet part shall not be facing the sky.

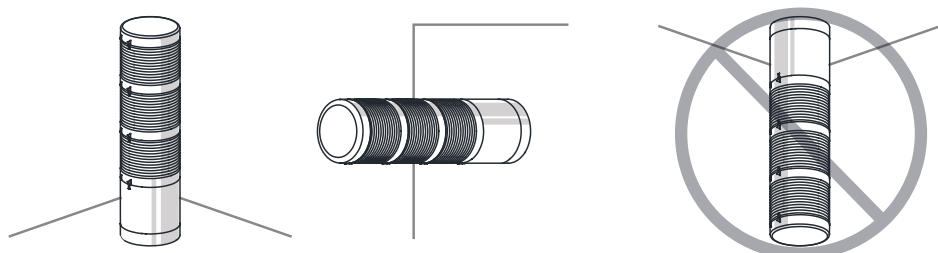

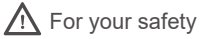

For your safety

Specification and dimensions listed in this catalogue subject to change without notice for product quality improvement.
The newest product information is available on our website.(www.qlight.com)
Please read the instruction manual attached to the product carefully before installation and use.

Korea Corporation Qlight Co., Ltd. www.qlight.com | trade@qlight.com

Head Office | Suite #1510, STX-V Tower, 128 Gasan Digital 1-ro, Geumcheon-gu, Seoul, 08507, South Korea

Tel: +82-2-2679-6152 Fax: +82-2-2679-6154

Factory(Gimhae Production Headquarters) | 185-25, Mukbang-ro, Sangdong-myeon, Gimhae-si, Gyeongsangnam-do, 50805, South Korea

Tel: +82-55-328-1111

Overseas Sales Department | Qlight Building, 704 Nakdong-daero, Sasang-gu, Busan 47044, South Korea Tel: +82-51-620-4100

Busan Business Center | Qlight Building, 704 Nakdong-daero, Sasang-gu, Busan 47044, South Korea Tel: +82-51-245-0017

China Corporation SHANGHAI Qlight Electronic Co., Ltd. www.qlight.com www.qlightcn.com | qlightcn@qlight.com

Sales Corporation (Shanghai) | Room 333 Building B, No.11, Lane 450, Zhenda Road, Baoshan District, Shanghai, China

Tel: +86-21-6651-7100 Fax: +86-21-6315-3929

Manufacturing Corporation (Qidong) | No.33, Haiyan Road, Qidong High-tech Industrial Development Zone, Qidong, Jiangsu Province, China

Tel: +86-513-8384-9999 Fax: +86-513-8384-9910

Qlightec

Innovation in Alarm & Signal

Product Operation Inquiry / Customer Support +82-51-620-4100

You can expect prompt service if you have exact information such as model name, symptom, telephone number and address.

※ALL PRODUCT, PRODUCT SPECIFICATIONS AND DATA ARE SUBJECT TO CHANGE WITHOUT NOTICE TO IMPROVE RELIABILITY, FUNCTION OR DESIGN OR OTHERWISE.

Head office : Suite #1510, STX-V Tower, 128 Gasan digital 1-ro, Geumcheon-gu, Seoul, Korea (Postal Code : 08507)

Factory : 185-25, Mukbang-Ro, Sangdong-Myeon, Gimhae-Si, Gyeongsangnam-Do, Korea (Postal Code : 50805)

www.qlight.com

Document No. : Manual_STB45ML-NEC(QPS)_230410

REV No. : rev 01

Date: 2026. 3. 17