

Q60L Series



Q60L



Q60LW

PRODUCT SPECIFICATION

Q60L | Q60LW | Q60LP

Materials Lens-PC, Housing-ABS, Mounting bracket-PC

Ambient operating temperature -30°C to +50°C

Volume Max.80dB at 1m

Protection rating IP65

Flashing rate 60-80/min

Compliant with RoHS directive

- Small-sized signal lights of 60mm diameter with attractive appearance
- Shock and vibration-resistant, maintenance reduced with long-lasting energy-efficient LED light bulbs
- Selectable mounts available depending on your application environment (direct mount, wall mount, pole mount)
- Features high visibility with special diffusive lens and direct LED light distribution system
- Built-in switch for selection between steady and flashing light mode
- Can select between standard and built-in buzzer type depending on installation environment

Q60L / Q60LW / Q60LP LED Steady/Flashing Signal Light

Model number	Voltage	Current	Certificates	Weight	Color
Q60L	DC12V-24V	Max.155mA	CE	Q60L-0.16kg Q60LW-0.18kg Q60LP-0.30kg (Including buzzer and standard pipe)	<ul style="list-style-type: none"> ● R-Red ● A-Amber ● G-Green ● B-Blue
Q60LW Q60LP					

· Various mounting options are available

※ DC type model has a free-voltage range of 10V-30V.

※ AC type model has a free-voltage range of 100V-240V.

※ UL Listed: DC24V

Wiring Instructions







- External Power line - UL1015 AWG18(0.75sq) x 2C 400mm
- This product can be wired regardless of polarity.

Customization

- Customized pole length available

Wiring Instructions

· Pole mount type

Standard	LB18	LW18	QZ18	SZ18	QL18	SL18
						
Steel	Steel	ABS	ABS	Al	ABS	Al

※ Please refer to [Tower Light Mounting Bracket] on this catalogue for detailed dimensions



Technical Diagram

Units: mm

·Q60L(Direct Mount)

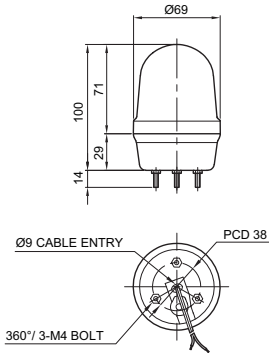

·Q60LP(Pole Mount)

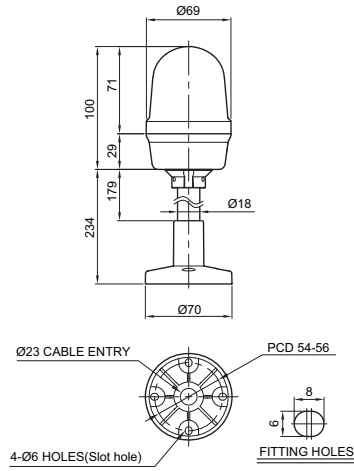

·Q60LW(Wall Mount)

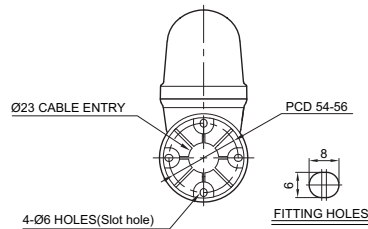
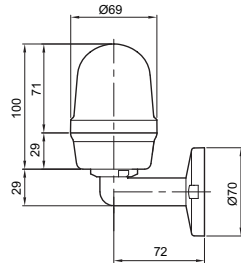

Q60LP
(SZ18 Bracket)

Ordering Specification

Q60LP	-	BZ	-	12/24	-	R	-	QZ18
[Model number] Q60L Q60LW Q60LP		[Buzzer option] (None) - No buzzer BZ - Built-in buzzer		[Voltage] 12/24-DC12V-24V 110/220-AC110V-220V		[Color] ● R-Red ● A-Amber ● G-Green ● B-Blue		[mount bracket] (None) - Standard Bracket -LB18 -LW18 -QZ18 -SZ18 -QL18 -SL18

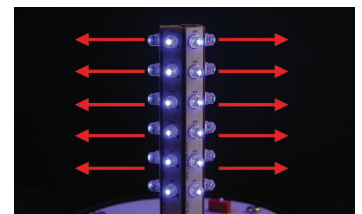

Direct Light Distribution LED Type

High brightness LED with a direct light distribution system makes the signal bright and clear, visible even from long distances.