

Signal phone for RS485 communication panel

CPK-RS485

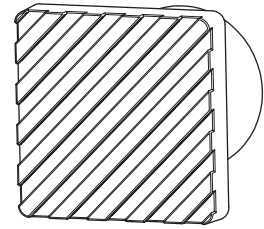

Thank you for purchasing Qlight's products. Please read this user manual carefully prior to installation and operation to ensure safe and correct use.

⚠ Precautions for Safety

Failure to follow the instructions below may cause a loss of life or serious physical injury.

1. During wiring or maintenance, please completely turn off the power of the product. (Failure to follow this may lead to an electric shock.)
2. Do not install the product in locations that subjects it to excessive dust or water other than the conditions designated by the IP protection ratings indicated for each product. (Failure to follow these instructions may cause a fire to the product, electric shock, physical injury, malfunction or damage to the product.)
3. Do not alter or repair this product. If maintenance or repair service is required, please contact your local Qlight contact point. (Failure to follow these instructions may lead to fire, electric shock, or product damage.)
4. Please apply the correct voltage to the product. (Failure to follow these instructions may lead to fire, electric shock, or product damage.)
5. When the product is applied to a condition that may impact lives or property, please make sure to have a double safety device. (Failure to follow this may cause damage to property, fire, electric shock and loss of life.)

⚠ Precautions for Correct Use

Failure to follow the proper instructions may cause damage to property, the product, and or malfunction of the product that would void the warranty.

1. Please remove any objects that can interrupt ventilation around the product.
2. Please turn off the power of the product immediately if it fails to operate properly.
3. Carefully wire the product according to each product's specification.
4. Please be careful in preventing chemicals such as thinner, benzene, etc. in contact with the surface of the product.
5. Do not apply excessive force/impact to the product.
6. Failure to follow any of the instructions above may cause malfunction or damage to the product, fire, and electric shock.

Ordering Specifications

CPK-RS485	-	12/24
[Model number]		[Voltage]
• CPK-RS485		• 12/24-DC12V-24V

Specifications

Model number	Sound Pattern	dB	Voltage	Current	Certificates	Weight
CPK-RS485	MP3 File (255 Sounds)	Max.90dB	DC12-24V	Max. 600mA	CE UL	0.21kg

※When playing MP3 files, there may be difference of volume depending on user's audio file type.

- **Protection rating : IP65**
- **Ambient operating temperature : -25°C to +50°C**



Please scan the QR code for more detailed product information.

www.qlight.com

CPK-RS485

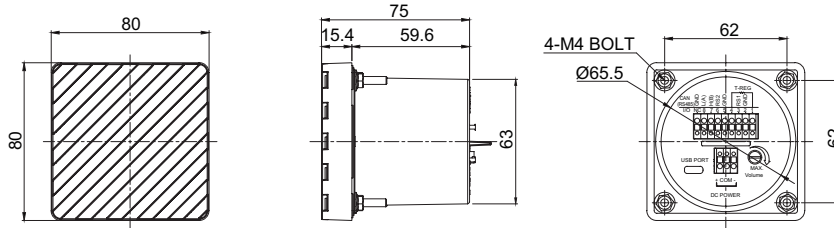

Wiring Instructions

- How to set 'T-REG'
 - If the product is installed at the end of RS485 Networks, please add a terminating resistor to the 'T-REG (Terminating Resistance)' position of the rear terminal blocks of the product.
 - The capacity of the terminating resistor is recommended with 120Ω/0.5W.
 - Please set RS1 and RS2 terminals on the backside of the unit for Baud rate setting.

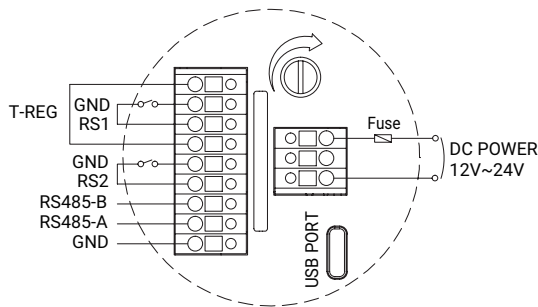

Baud rate Select		
RS2	RS1	Communication speed
OFF	OFF	9,600bps
OFF	ON	19,200bps
ON	OFF	38,400bps
ON	ON	115,200bps

- ON: RS1/RS2 terminals are connected to GND ()
- OFF: RS1/RS2 terminals are NOT connected to GND ()

- When wiring with power line, please check the voltage at the terminals.
- ※ Applicable cable range : AWG16-AWG24

Parts Definition/ Installation / Mounting Hole Specifications

■ Parts Definition/ Installation

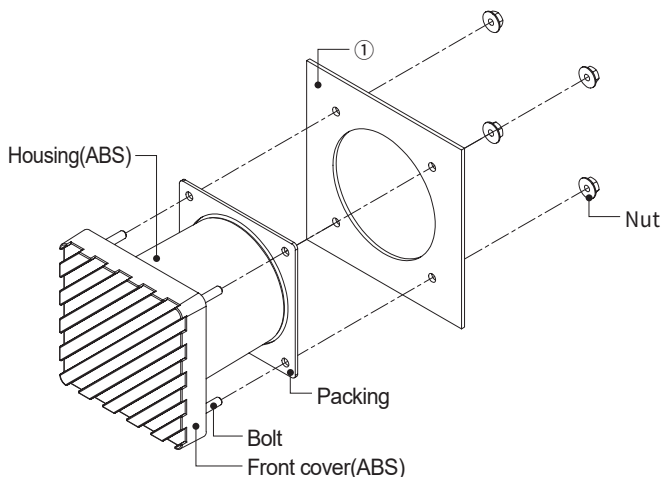

■ Mounting Hole Specifications

- Machine holes on the mounting surface referring to the diagram below.

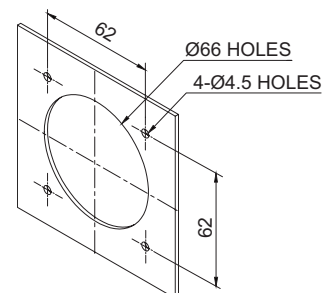

- First, machine taps or holes on the mounting surface①.
- The mounting hole of this product bracket is 4.5mm in diameter.
- When machining taps, fasten the bolt through the mounting hole of the bracket.
- When machining holes, insert the bolt through the hole of the bracket, and tighten the nut from the opposite side of the mounting surface.

Product manual

■ How to connect with PC and save MP3 audio file

1. Please turn the unit off and connect USB C-TYPE cable on the backside of CPK-RS485
2. Please create "01" folder on your PC and save the MP3 file in the 01 folder.
 - Max number of channels: 255 channels,
 - Max memory size: 128Mbyte
3. Please disconnect the USB cable after safely removing the USB from the PC.

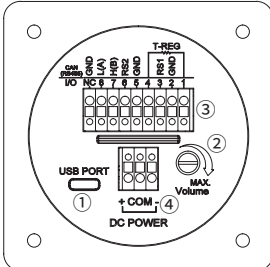

<USB connector at the back side of CPK-RS485>

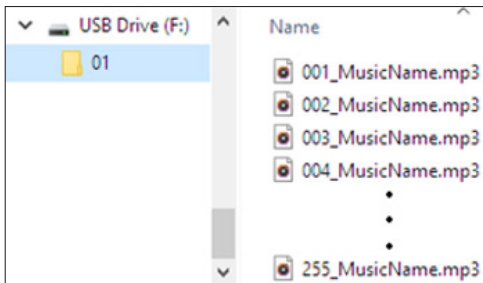

<Built-in memory folder and audio file name>

■ File format

- Following instruction is how to name an audio file name.

Example > .mp3

Filename (Korean/Chinese Up to 20 characters, English Up to 40 characters)
Separator (Track# and file title)
Track#

- Power connection
 - Power on with rated power at ④ 3P terminal at the back side of the unit.
 - It requires approximately 3 seconds to product initiation.
- Volume control
 - It controls volume. Raise the buzzer volume by sliding the ② control lever clockwise(CW). Reduce the buzzer volume by sliding the ② control lever counterclockwise(CCW).
- RS485 communication connection
 - ③input terminal can configure RS485 communication connection, terminating resistance and Baud rate.
 - Please refer to the manual regarding detailed terminal information.

Sound selection and control

- Possible to select and control sound through RS485 communication. Please refer to the user's manual on the website for RS485 communication protocol data.

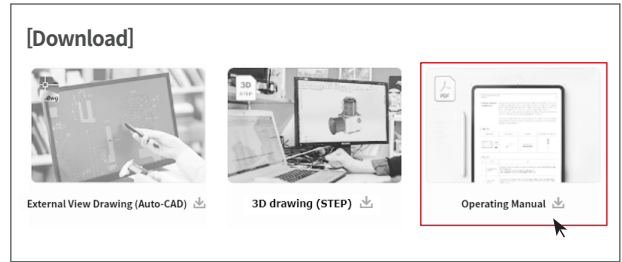

Volume Adjustment

- The volume output of this product is adjustable.
- Turn the volume dial clockwise to increase the volume, and turn counterclockwise to decrease the volume.
- There will be no sound when the dial is put at MIN.

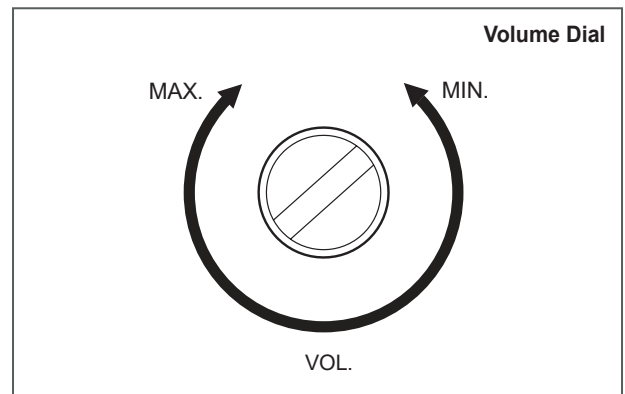

Installation Environment and Protection Rating

- This product is designed for use with protection rating of IP65.
- In case of outdoor applications, install the product in the upright position. Do not install the product horizontal or upsidedown positions where water can potentially penetrate into the product and impact it's operation.
- For further information, please visit our website (www.qlight.com).



For your safety

Specification and dimensions listed in this catalogue subject to change without notice for product quality improvement.
The newest product information is available on our website.(www.qlight.com)
Please read the instruction manual attached to the product carefully before installation and use.

Korea Corporation Qlight Co., Ltd. www.qlight.com | trade@qlight.com

Head Office | Suite #1510, STX-V Tower, 128 Gasan Digital 1-ro, Geumcheon-gu, Seoul, 08507, South Korea

Tel: +82-2-2679-6152 Fax: +82-2-2679-6154

Factory(Gimhae Production Headquarters) | 185-25, Mukbang-ro, Sangdong-myeon, Gimhae-si, Gyeongsangnam-do, 50805, South Korea

Tel: +82-55-328-1111

Overseas Sales Department | Qlight Building, 704 Nakdong-daero, Sasang-gu, Busan 47044, South Korea Tel: +82-51-620-4100

Busan Business Center | Qlight Building, 704 Nakdong-daero, Sasang-gu, Busan 47044, South Korea Tel: +82-51-245-0017

China Corporation SHANGHAI Qlight Electronic Co., Ltd. www.qlight.com www.qlightcn.com | qlightcn@qlight.com

Sales Corporation (Shanghai) | Room 333 Building B, No.11, Lane 450, Zhenda Road, Baoshan District, Shanghai, China

Tel: +86-21-6651-7100 Fax: +86-21-6315-3929

Manufacturing Corporation (Qidong) | No.33, Haiyan Road, Qidong High-tech Industrial Development Zone, Qidong, Jiangsu Province, China

Tel: +86-513-8384-9999 Fax: +86-513-8384-9910

Qlightec

Innovation in Alarm & Signal

Product Operation Inquiry / Customer Support +82-51-620-4100

You can expect prompt service if you have exact information such as model name, symptom, telephone number and address.

※ ALL PRODUCT, PRODUCT SPECIFICATIONS AND DATA ARE SUBJECT TO CHANGE WITHOUT NOTICE TO IMPROVE RELIABILITY, FUNCTION OR DESIGN OR OTHERWISE.

Head office : Suite #1510, STX-V Tower, 128 Gasan digital 1-ro, Geumcheon-gu, Seoul, Korea (Postal Code : 08507)

Factory : 185-25, Mukbang-Ro, Sangdong-Myeon, Gimhae-Si, Gyeongsangnam-Do, Korea (Postal Code : 50805)

www.qlight.com

EN - CPK-RS485 - 2606A